

GYNEMED

Fertility Treatment

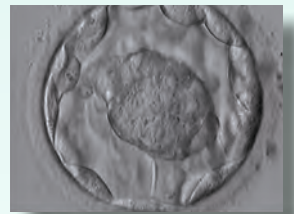
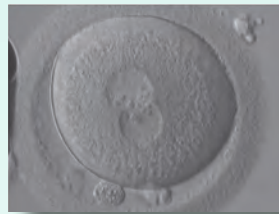
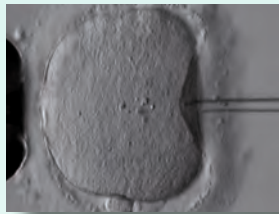
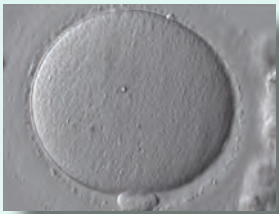

Helps when others fail

INDEX

Oocyte Handling

- GM501 Flush **1 - 5**
 - GM501 Wash
 - GM501 Wash with Phenolred and Gentamicin
 - GM501 Hyaluronidase

 - Hyaluronidase treatment - Recommended application
-

Culture

- GM501 Basic **6 - 11**
 - GM501 Cult
 - GM501 Cult with Gentamicin
 - GM501 Cult with Gentamicin and Phenolred
 - GM501 Mineral Oil

 - Embryo culture - Recommended application
-

Sperm Processing

- GM501 SpermAir **12 - 20**
 - GM501 SpermActive
 - GM501 Gradient
 - GM501 PVP

 - Swim-Up - Recommended application
 - Density centrifugation - Recommended application

 - GM501 Insemination Kit

 - GM501 Insemination Kit - Recommended application
-

Cryopreservation

- GM501 EmbryoStore 21 - 30
 - GM501 VitriStore Freeze Kit
 - GM501 VitriStore Thaw Kit
 - GM501 GentleVit Freeze Kit
 - GM501 GentleVit Thaw Kit
 - GM501 SpermStore

 - Slow freezing - Recommended application
 - Vitrification and Thawing- Recommended application
 - Sperm freezing - Recommended application
-

Enzymes

Miscellaneous

In-Vitro-Diagnostics

- Bromelain in Dulbecco's PBS 31 - 41
 - GM501 Collagenase
 - GM501 HSA

 - Liquefaction - Recommended application
 - Collagenase treatment - Recommended application

 - GM501 SpermMobil
 - GM508 CultActive

 - GM501 SpermMobil - Recommended application
 - GM508 CultActive - Recommended application

 - Semen - Diagnostics
-

Pipettes

- Holding micropipettes 42 - 47
 - Injection micropipettes
 - Hatching micropipettes
 - Biopsy micropipettes
 - Denuding micropipettes
 - DENU-Tips
-

Oocyte Handling



GM501 Flush

- Ready-to-use
- HEPES buffered (21 mM)
- CO₂-incubation is not required
- Contains Heparin (2.5 IU/ml)
- CE marked class III (0344)



Intended use

Cell culture medium for human oocyte pick-up. GM501 Flush is a ready-to-use medium for flushing the ovarian follicles during the aspiration and/or oocyte pick-up intended for extra corporeal fertilisation procedures.

Instructions for use

GM501 Flush needs to be warmed at 37°C over night before use (no CO₂, with closed lid). GM501 Flush is HEPES buffered. Incubation in a CO₂-incubator will lower the pH.

Composition

- NaCl, KCl, KH₂PO₄, MgSO₄, CaCl₂
- Bicarbonate, HEPES, EDTA
- Glucose, Lactate, Pyruvate
- Non-essential and essential Amino Acids, Alanyl-Glutamine
- Heparin

Tested specifications

- pH
- Osmolality
- Sterility
- Endotoxins
- MEA

Ref. No.

Size

Storage

Shelf life*

4 GM 501F-50

1 x 50 ml

2 - 8°C

6 months

4 GM 501F-500

1 x 500 ml

2 - 8°C

6 months

* from time of manufacture

On request also available in the sizes 20 ml, 100 ml and 250 ml

GM501 Wash

- Ready-to-use
- HEPES (15 mM) and bicarbonate buffered
- After CO₂ incubation the medium is stable at room atmosphere for short-term handling procedures
- Contains Human Serum Albumin (5.00 g/liter)
- CE marked class III (0344)



Intended use

GM501 Wash is a ready-to-use medium designed for washing procedures of human oocytes and embryos and any short-term handling procedures outside the incubator like washing after Hyaluronidase treatment (denudation), ICSI, polar body or blastomere biopsy.

Composition

- NaCl, KCl, KH₂PO₄, MgSO₄, CaCl₂
- Bicarbonate, HEPES, EDTA
- Glucose, Lactate, Pyruvate
- Non-essential and essential Amino Acids, Alanine-Glutamine
- Human Serum Albumin

Instructions for use

GM501 Wash must be equilibrated over night in a humidified CO₂-incubator (at 5 - 7% CO₂, 37°C).

Tested specifications

- pH
- Osmolality
- Sterility
- Endotoxins
- MEA

Ref. No.	Size	Storage	Shelf life*
4 GM 501W-20	1 x 20 ml	2 - 8°C	6 months
4 GM 501W-50	1 x 50 ml	2 - 8°C	6 months
4 GM 501W-500	1 x 500 ml	2 - 8°C	6 months

GM501 Wash with Phenolred and Gentamicin

- Ready-to-use
- HEPES (15 mM) and bicarbonate buffered
- After CO₂ incubation the medium is stable at room atmosphere for short-term handling procedures
- Contains Human Serum Albumin (5.00 g/liter)
- Contains Gentamicin (10 mg/liter)
- Contains Phenolred
- CE marked class III (0344)



Intended use

GM501 Wash with Phenolred and Gentamicin is a ready-to-use medium designed for washing procedures of human oocytes and embryos and any short-term handling procedures outside the incubator like washing after Hyaluronidase treatment (denudation), ICSI, polar body or blastomere biopsy and other.

Composition

- NaCl, KCl, KH₂PO₄, MgSO₄, CaCl₂
- Bicarbonate, HEPES, EDTA
- Glucose, Lactate, Pyruvate
- Non-essential and essential Amino Acids, Alanine-Glutamine
- Human Serum Albumin, Gentamicin, Phenolred

Instructions for use

GM501 Wash with Phenolred and Gentamicin must be equilibrated over night in a humidified CO₂-incubator (at 5 - 7% CO₂, 37°C).

Tested specifications

- pH
- Osmolality
- Sterility
- Endotoxins
- MEA

Ref. No.	Size	Storage	Shelf life*
4 GM 501W+PR+G-20	1 x 20 ml	2 - 8°C	6 months
4 GM 501W+PR+G-50	1 x 50 ml	2 - 8°C	6 months

* from time of manufacture

GM501 Hyaluronidase

- Ready-to-use
- HEPES buffered
- CO₂-incubation is not required
- Contains Human Serum Albumin (4.00 g/liter)
- Contains pharmaceutical grade hyaluronidase (80 IU/ml)
- CE marked Class III (0344)



Intended use

GM501 Hyaluronidase is a ready-to-use solution designed to facilitate the removal of cumulus cells. Hyaluronidase digests the extracellular matrix in the cumulus-oocyte complex consisting of hyaluronic acid.

Composition

- NaCl, KCl, NaH₂PO₄, MgSO₄, CaCl₂
- Bicarbonate, HEPES
- Glucose, Lactate, Pyruvate
- Human Serum Albumin
- Pharmaceutical grade hyaluronidase from bovine origin

Can be used in combination with

- GM501 Cult media
- GM501 Wash
- GM501 Mineral Oil

Instructions for use

GM501 Hyaluronidase contains HEPES; no CO₂-incubation is required, just warm it up to 37°C.

For further information see page 5.

Tested specifications

- pH
- Osmolality
- Sterility
- Endotoxins
- MEA

Ref. No.	Size	Storage	Shelf life*
4 HY 0010	1 x 10 ml	2 - 8°C	12 months
4 HY 0001-5	5 x 1 ml	2 - 8°C	12 months

GM501 Hyaluronidase

Recommended application

Preparation for denudation of fresh oocytes:

Preparation of the 4-well dish

- One 4-well dish (“Hya-dish”) needs to be prepared for 10 oocytes.
- First fill well 2 to 4 with 400 μ l GM501 Wash medium and cover the filled wells with GM501 Mineral Oil. Equilibrate the dish overnight in a humidified CO₂ incubator.
- Warm the GM501 Hyaluronidase and fill the first well with 400 μ l warmed GM501 Hyaluronidase.

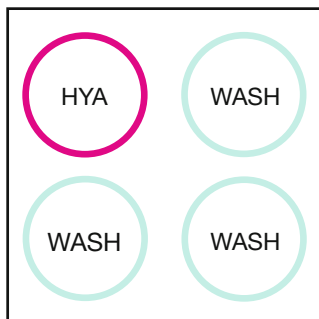

Preparation of microdrop dish

- One 60 mm Petri dish (“Hya-dish”) needs to be prepared for 10 oocytes.
- Each dish contains a total of 7 drops, 80 μ l each (6x GM501 Wash medium, 1x GM501 Hyaluronidase). In the graph the wash drops are shown in green and the hyaluronidase drop is shown in pink.
- To facilitate identification mark the spot for Hyaluronidase drop on the bottom of the petri dish. First add the 6 drops with GM501 Wash medium to the dish and cover with GM501 Mineral Oil. Equilibrate the dish overnight in a humidified CO₂ incubator.
- Warm the GM501 Hyaluronidase and add one drop of 80 GM501 Hyaluronidase to the dish at the marked position.

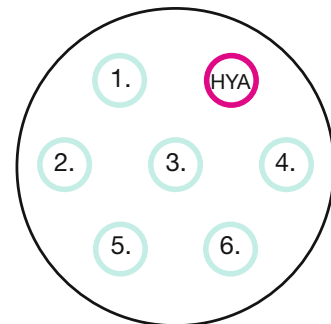

Denudation procedure using the microdrop dish

1. Pipette up to 10 oocytes into the first drop (“1”) of the dish.
2. Transfer 5 oocytes to the “Hya” drop.
3. Pipet the oocytes immediately up and down (5 to 10 times) using for example an pipette with 100 μ l tip (MEA-tested) adjusted to 50 μ l. The cumulus cells will detach and the oocytes still surrounded by corona cells will be visible. **ATTENTION: The oocytes should not be in the Hyaluronidase for more than 30 seconds!**
4. Pick up the oocytes using the denudation pipette (inner diameter 125-155 μ m) and transfer them to the next GM501 Wash containing drop (“2”). Aspirate and blow back the oocytes repeatedly to remove residual hyaluronidase.
5. Transfer the oocytes to the next GM501 Wash containing drop (“3”). Aspirate and blow back the oocytes repeatedly until nearly all corona cells are removed.
6. Transfer the oocytes to the next GM501 Wash containing drop (“4”). Leave the denuded oocytes in this drop.
7. Repeat steps 2 to 6 with the remaining oocytes.
8. When all oocytes are collected in GM501 Wash drop “4” and are free of cumulus and corona cells, wash them in the last two drops (“5” and “6”).
9. The denuded oocytes can then be transferred to a dish containing GM501 Cult for further incubation until ICSI is performed or directly to an ICSI dish.

Culture



GM501 Basic

- Bicarbonate buffered
- Single step medium - from fertilization to blastocyst stage
- Can be used with or without medium change at day 3
- Suitable for microdrop (single and group) culture under oil and open culture systems
- CE marked class IIb (0482)



Intended use

GM501 Basic is a bicarbonate buffered culture medium, designed for fertilization and for human embryo culture from day 1 to blastocyst stage. It can also be used for embryo transfer.

Composition

- NaCl, KCl, KH_2PO_4 , MgSO_4 , CaCl_2
- Bicarbonate, EDTA
- Glucose, Lactate, Pyruvate
- Non-essential and essential Amino Acids, Alanine-Glutamine

Can be used in combination with

- GM501 HSA

Tested specifications

- pH
- Osmolality
- Sterility
- Endotoxins
- MEA

Instructions for use

GM501 Basic must be supplemented with Human Albumin Solution to a protein end concentration of 1% (w/v). The use of GM501 HSA is strongly recommended. To supplement the 50 ml unit, keep 45 ml medium in the bottle and add 5 ml of GM501 HSA. Mix well. Embryo culture media must be equilibrated over night in a humidified CO_2 -incubator (at 5 - 7% CO_2 , 37°C). GM501 Basic is designed for embryo culture under oil as well as in open systems.

References

- Ebert P., Szypajlo B., Tomalak K., Völklein K. (2009): Prospective comparison of two commercially available culture media under the provisions of the German embryo protection law. J Turkish-German Gynecol Assoc 10: 10-13
- Eue I., Schwahn E., Merzenich M., Häberlin F. (2007): First Clinical Experience with GM501 - a New KSOM^{AA} based Embryo Culture Medium. Annual meeting of German IVF-Groups, Kiel.
- Weiss D., Schneider U. (2006): In vitro culture of human embryos up to day five in simplex optimized medium GM501. Gynemedica.

Ref. No.

Size

Storage

Shelf life*

4 GM 501-50

1 x 50 ml

2 - 8°C

6 months

4 GM 501-500

1 x 500 ml

2 - 8°C

6 months

* from time of manufacture

On request also available in the sizes 20 ml, 100 ml and 250 ml

GM501 Cult

- Ready-to-use
- Bicarbonate buffered
- Single step medium - from fertilization to blastocyst stage
- Can be used with or without medium change at day 3
- Suitable for microdrop (single and group) culture under oil and open culture systems
- Contains Human Serum Albumin (10.00 g/liter)
- CE marked class III (0344)



Intended use

GM501 Cult is a ready-to-use bicarbonate buffered culture medium, designed for fertilization and for human embryo culture from day 1 to blastocyst stage. It can also be used for embryo transfer.

Composition

- NaCl, KCl, KH_2PO_4 , MgSO_4 , CaCl_2
- Bicarbonate, EDTA
- Glucose, Lactate, Pyruvate
- Non-essential and essential Amino Acids, Alanine-Glutamine
- Human Serum Albumin

Can be used in combination with

- GM501 Mineral Oil

Instructions for use

GM501 Cult must be equilibrated over night in a humidified CO_2 -incubator (at 5 - 7% CO_2 , 37°C).

For further information see page 10.

Tested specifications

- pH
- Osmolality
- Sterility
- Endotoxins
- MEA

References

- Eue I., Schwahn E., Merzenich M., Häberlin F. (2007): First Clinical Experience with GM501 - a New KSOM^{AA} based Embryo Culture Medium. Annual meeting of German IVF-Groups, Kiel.
- Weiss D., Schneider U. (2006): In vitro culture of human embryos up to day five in simplex optimized medium GM501. Gynemedia.

Ref. No.	Size	Storage	Shelf life*
4 GM 501H-20	1 x 20 ml	2 - 8°C	6 months
4 GM 501H-50	1 x 50 ml	2 - 8°C	6 months

GM501 Cult with Gentamicin

- Ready-to-use
- Bicarbonate buffered
- Single step medium - from fertilization to blastocyst stage
- Can be used with or without medium change at day 3
- Suitable for microdrop (single and group) culture under oil and open culture systems
- Contains Gentamicin (10.00 mg/liter)
- Contains Human Serum Albumin (10.00 g/liter)
- CE marked class III (0344)



Intended use

GM501 Cult with Gentamicin is a ready-to-use bicarbonate buffered culture medium, designed for fertilization and for human embryo culture from day 1 to blastocyst stage. It can also be used for embryo transfer.

Composition

- NaCl, KCl, KH_2PO_4 , MgSO_4 , CaCl_2
- Bicarbonate, EDTA
- Glucose, Lactate, Pyruvate
- Non-essential and essential Amino Acids, Alanine-Glutamine
- Human Serum Albumin, Gentamicin

Can be used in combination with

- GM501 Mineral Oil

Instructions for use

GM501 Cult with Gentamicin must be equilibrated over night in a humidified CO_2 -incubator (at 5 - 7% CO_2 , 37°C).

For further information see page 10.

Tested specifications

- pH
- Osmolality
- Sterility
- Endotoxins
- MEA

References

- Campo R., Binda M.M., Van Kerkhoven G., Frederickx V., Serneels A., Roziers P., Lopes A.S., Gordts Sy., Puttemans P., Gordts S. (2010): Critical reappraisal of embryo quality as a predictive parameter for pregnancy outcome: a pilot study. *F, V & V in ObGyn* 2: 289-295.
- Kemeter P., Hajek J., Feichtinger W. (2011): Eine prospektiv-randomisierte Studie zum Vergleich zweier Embryo-Kultursysteme nach IVF/ICSI: Sequential media in 5% O_2 -Atmosphäre und Single medium in 21% O_2 -Atmosphäre. *J Gynäkol Endokrinol* 21: 16-21.

Ref. No.	Size	Storage	Shelf life*
4 GM 501H+G-20	1 x 20 ml	2 - 8°C	6 months
4 GM 501H+G-50	1 x 50 ml	2 - 8°C	6 months

* from time of manufacture

GM501 Cult with Gentamicin and Phenolred

- Ready-to-use
- Bicarbonate buffered
- Single step medium - from fertilization to blastocyst stage
- Can be used with or without medium change at day 3
- Suitable for microdrop (single and group) culture under oil and open culture systems
- Contains Gentamicin (10.00 mg/liter)
- Contains Human Serum Albumin (10.00 g/liter)
- Contains Phenolred
- CE marked class III (0344)



Intended use

GM501 Cult with Gentamicin and Phenolred is a ready-to-use bicarbonate buffered culture medium, designed for fertilization and for human embryo culture from day 1 to blastocyst stage. It can also be used for embryo transfer.

Composition

- NaCl, KCl, KH_2PO_4 , MgSO_4 , CaCl_2
- Bicarbonate, EDTA
- Glucose, Lactate, Pyruvate
- Non-essential and essential Amino Acids, Alanine-Glutamine
- Human Serum Albumin, Gentamicin, Phenolred

Can be used in combination with

- GM501 Mineral Oil

Instructions for use

GM501 Cult with Gentamicin and Phenolred must be equilibrated over night in a humidified CO_2 -incubator (at 5 - 7% CO_2 , 37°C).

For further information see page 10.

Tested specifications

- pH
- Osmolality
- Sterility
- Endotoxins
- MEA

References

- Paternot G., Debrock S., D'Hooghe T.M., Spiessens C. (2010): Early embryo development in a sequential versus single medium: a randomized study. *Reproductive Biology and Endocrinology* 7: 83.
- Gruber I., Klein M. (2011): Embryo culture media for human IVF: which possibilities exist? *J Turkish-German Gynecol Assoc* 12: 110-117.

Ref. No.	Size	Storage	Shelf life*
4 GM 501H+PR+G-20	1 x 20 ml	2 - 8°C	6 months
4 GM 501H+PR+G-50	1 x 50 ml	2 - 8°C	6 months

GM501 Mineral Oil

- Ready-to-use
- Stabilize the pH during IVF, ICSI and related artificial reproductive techniques
- CE marked class IIa (0482)



Intended use

GM501 Mineral Oil is a ready-to-use oil for covering the medium during IVF/ICSI treatment. GM501 Mineral Oil protects the medium from evaporation and thereby stabilizes PH and temperature.

Composition

- Paraffin oil
- Density 0.83 - 0.86
- Viscosity < 30 cP at 30°C
- Pre-washed twice with ultra-pure water

Can be used in combination with

- GM501 Cult media
- GM501 PVP
- GM501 Hyaluronidase

Instructions for use

GM501 Mineral Oil is a pre-washed ready-to-use oil, so no further preparations are necessary. After pre-incubation (5 hours/37°C) overlay the culture medium with GM501 Mineral Oil until it is completely covered.

For further information see page 10.

Tested specifications

- Density
- Viscosity
- Sterility
- Endotoxins
- MEA
- Peroxide level

References

- Gallardo E.F., Spiessens C, D'Hooghe T., Debrock S (2016): Effect of embryo morphology and morphometrics on implantation of vitrified day 3 embryos after warming: a retrospective cohort study. *Reproductive Biology and Endocrinology* 14:40

Ref. No.	Size	Storage	Shelf life*
4 MO 0100	1 x 100 ml	15 - 25°C	18 months
4 MO 0500	1 x 500 ml	15 - 25°C	18 months

* from time of manufacture

Embryo Culture

Recommended application for IVF and ICSI

4-well dish

Day “-1”:

Prepare a 4-well dish by filling each well with 400 µl of GM501 Cult. Cover the wells completely with GM501 Mineral Oil and equilibrate overnight in a CO₂ atmosphere at 37°C.

Day “0”:

ICSI

Directly after microinjection add up to 6 oocytes per well for culture.

IVF

Add up to 6 oocytes per well for fertilization and add the appropriate amount of prepared spermatozoa. Prepare an additional 4-well dish in the same fashion for the next day.

Day “1”:

ICSI

No further intervention necessary. If desired, assess pronuclear status.

IVF

Carefully remove remaining cumulus and corona cells by pipetting and transfer the fertilized oocytes to the prepared “culture” dish.

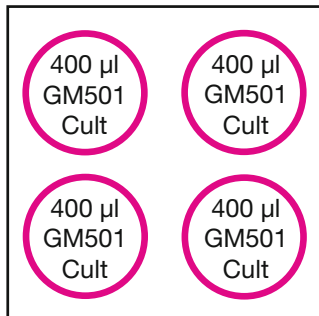

Microdrop dish

Day “-1”:

Prepare a microdrop dish with sufficient 80 - 100 µl drops (group culture) or 30 - 50 µl drops (single embryo culture) of GM501 Cult and cover completely with GM501 Mineral Oil. Equilibrate overnight in a CO₂ atmosphere at 37°C.

Day “0”:

ICSI

Directly after microinjection add the desired amount of oocytes to the respective drops (e.g. 3 oocytes per drop for group culture).

IVF

Add 2-3 oocytes per drop for fertilization and add the appropriate amount of prepared spermatozoa. Prepare an additional dish in the same fashion for the next day (“culture” dish).

Day “1”:

ICSI

No further intervention necessary. If desired, assess pronuclear status.

IVF

Carefully remove remaining cumulus and corona cells by pipetting and transfer the fertilized oocytes to the prepared “culture” dish.

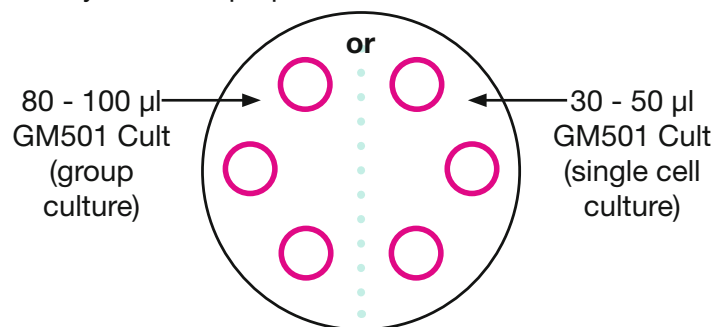

Simple „one-step“ culture:

Day -1	Day 0	Day 1	Day 2 or 3
Preparation of dishes for IVF or ICSI using GM501 Cult Media	Fertilization by IVF or ICSI and culture in GM501 Cult Media	Ongoing culture in GM501 Cult Media	Embryo transfer

Extended „one-step“ culture:

Day -1	Day 0	Day 1	Day 2	Day 3	Day 4	Day 5
Preparation of dishes for IVF or ICSI using GM501 Cult Media	Fertilization by IVF or ICSI and culture in GM501 Cult Media	Ongoing culture in GM501 Cult Media	Ongoing culture in GM501 Cult Media. Preparation of new dishes for day 3 if wanted	Ongoing culture in new dishes with GM501 Cult Media	Ongoing culture in GM501 Cult Media	Embryo transfer

Laboratory Equipment and Services



Micromanipulation



Laser Systems



Microscopes



Work Bench



Standard Incubation



Benchtop Incubation



Data Monitoring



Cleanroom Service



Sperm Processing



GM501 SpermAir

- Ready-to-use
- HEPES buffered (21 mM)
- CO₂-incubation is not required
- For all human sperm handling and preparation procedures
- Suitable for washing, swim-up and density gradient centrifugation
- For handling of testicular tissue
- Contains Gentamicin (10.00 mg/liter)
- Contains Phenolred
- Contains Human Serum Albumin (5.00 g/liter)
- CE marked class III (0344)



Intended use

GM501 SpermAir is a ready-to-use medium designed for all human sperm preparation, sperm washing, swim up techniques and density gradient centrifugation as well as for testicular tissue.

Composition

- NaCl, KCl, KH₂PO₄, MgSO₄, CaCl₂
- Bicarbonate, HEPES, EDTA
- Glucose, Lactate, Pyruvate
- Non-essential and essential Amino Acids, Alanine-Glutamine
- Human Serum Albumin, Gentamicin, Phenolred

Instructions for use

Do not equilibrate GM501 SpermAir in a CO₂-incubator, just warm it up to 37°C. GM501 SpermAir is HEPES buffered. Incubation in a CO₂-incubator will lower the pH.

For further information see page 16-17.

Tested specifications

- pH
- Osmolality
- Sterility
- Endotoxins
- MEA

Ref. No.	Size	Storage	Shelf life*
4 GM 501AIR+PR+G-20	1 x 20 ml	2 - 8°C	6 months
4 GM 501AIR+PR+G-50	1 x 50 ml	2 - 8°C	6 months

* from time of manufacture

GM501 SpermActive

- Ready-to-use
- HEPES (15 mM) and bicarbonate buffered
- After CO₂ incubation the medium is stable at room atmosphere for short-term handling procedures.
- For all human sperm handling and preparation procedures
- Suitable for washing, swim-up and density gradient centrifugation
- For handling of testicular tissue
- Contains Gentamicin (10.00 mg/liter)
- Contains Phenolred
- Contains Human Serum Albumin (5.00 g/liter)
- CE marked class III (0344)



Intended use

GM501 SpermActive is a ready-to-use medium designed for all human sperm preparation, sperm washing, swim up techniques and density gradient centrifugation as well as for testicular tissue.

Composition

- NaCl, KCl, KH₂PO₄, MgSO₄, CaCl₂
- Bicarbonate, HEPES, EDTA
- Glucose, Lactate, Pyruvate
- Non-essential and essential Amino Acids, Alanine-Glutamine
- Human Serum Albumin, Gentamicin, Phenolred

Instructions for use

GM501 SpermActive must be equilibrated over night in a humidified CO₂-incubator (at 5 - 7% CO₂, 37°C).

For further information see page 16-17.

Tested specifications

- pH
- Osmolality
- Sterility
- Endotoxins
- MEA

Ref. No.	Size	Storage	Shelf life*
4 GM 501SA-020	1 x 20 ml	2 - 8°C	6 months
4 GM 501SA-050	1 x 50 ml	2 - 8°C	6 months

GM501 Gradient

- Ready-to-use (45%, 90%)
- Stock solution (100%) can be diluted to your own preferences
- Consists of silane-coated colloidal silica particles suspended in HEPES buffered medium
- Can be used in combination with IUI, IVF and ICSI
- CE marked class IIb (0482)



Intended use

GM501 Gradient is an isotonic solution for semen preparation with a density of approximately 1.12 g/ml.

Tested specifications

- pH
- Osmolality
- Density
- Viscosity
- Sterility
- Endotoxins
- Sperm Survival Test

Can be used in combination with

- GM501 SpermAir
- GM501 SpermActive

Instructions for use

Mix the density gradient bottles by 5 bottle inversions before use. We advice to produce a 2-phase system from the 100% gradient (45% and 90%). You may prefer a different mixing ratio (e.g. 40% and 80%) or a multi layer gradient (45%-70%-90%). Mix 9 parts of GM501 Gradient 100% with 1 parts of washing medium to produce the 90% gradient. Mix 4.5 parts of GM501 Gradient 100% with 5.5 parts of washing medium to produce the 45% gradient.

For further information see page 18.

Note: Gradients should be prepared and repacked under sterile conditions (e.g. LAF-bench, ISO Class 5). For optimal results prepare the gradient media maximum 24 hours prior to use. Mix well after diluting the GM501 Gradient 100%.

Ref. No.	Size	Storage	Shelf life*
4 GM501G-100-50	1 x 50 ml	2 - 8°C	18 months
4 GM501G-100-100	1 x 100 ml	2 - 8°C	18 months
4 GM501G-100-250	1 x 250 ml	2 - 8°C	18 months
4 GM501G-100-500	1 x 500 ml	2 - 8°C	18 months
4 GM501G-90-10	1 x 10 ml	2 - 8°C	18 months
4 GM501G-90-50	1 x 50 ml	2 - 8°C	18 months
4 GM501G-90-100	1 x 100 ml	2 - 8°C	18 months
4 GM501G-90-250	1 x 250 ml	2 - 8°C	18 months
4 GM501G-45-10	1 x 10 ml	2 - 8°C	18 months
4 GM501G-45-50	1 x 50 ml	2 - 8°C	18 months
4 GM501G-45-100	1 x 100 ml	2 - 8°C	18 months
4 GM501G-45-250	1 x 250 ml	2 - 8°C	18 months

* from time of manufacture

GM501 PVP

- Ready-to-use
- HEPES buffered
- Can be diluted with HEPES buffered medium
- Reduces the motility of spermatozoa to facilitate sperm pick-up for ICSI
- Contains Human Serum Albumin (4.00 g/liter)
- Contains pHEur grade Polyvinylpyrrolidone 10% (100.00 g/liter)
- CE marked class III (0344)



Intended use

GM501 PVP is a ready-to-use media to reduce the motility of sperm making it easier to catch them with an ICSI pipette. It is possible to dilute the solution with HEPES buffered sperm processing media.

Composition

- NaCl, KCl, NaH₂PO₄, MgSO₄, CaCl₂
- Bicarbonate, HEPES
- Glucose, Lactate, Pyruvate
- Human Serum Albumin, Polyvinylpyrrolidone

Tested specifications

- pH
- Osmolality
- Sterility
- Endotoxins
- MEA

Can be used in combination with

- GM501 Mineral Oil
- GM501 SpermAir
- GM501 SpermActive

Ref. No.	Size	Storage	Shelf life*
4 PVP 0001	1 x 1 ml	2 - 8°C	9 months
4 PVP 0001-5	5 x 0.2 ml	2 - 8°C	9 months

Instructions for use

Warm the PVP solution to 37°C

Standard procedure:

Place a small drop of PVP solution (5 µl - 10 µl) in a dish and cover with GM501 Mineral Oil. Add a small volume (1 µl - 2 µl) of washed sperm cells into the centre of the PVP droplet. Wait for a few minutes to allow the sperm cells to migrate to the periphery of the droplet. Select and recover the spermatozoa for injection.

Warm the PVP solution and HEPES buffered sperm processing medium to 37°C.

Alternative procedure (with extra washing step):

Place a small drop of PVP solution (5 µl - 10 µl) and 1 or more small drops HEPES buffered sperm processing medium in a dish and cover with GM501 Mineral Oil. Add a small volume (1 µl - 2 µl) of washed sperm cells into the centre of the PVP droplet.

Wait for a few minutes to allow the sperm cells to migrate to the periphery of the droplet. Select the spermatozoa for injection and nick (break) the tail of the spermatozoon with the tip of the pipette. Transfer the spermatozoon into one of the HEPES buffered sperm processing medium droplets and wash by transferring the sperm cell in and out of the sperm processing medium several times. Aspirate the sperm cell into the pipette and use for ICSI procedure.

Swim-Up

Recommended application for indirect Swim-Up

Preparation:

We recommend one of the products from the GM501 MediaLine:

- GM501 SpermAir or
- GM501 SpermActive

Washing 1

To prepare the swim-up tubes transfer 4.5 ml medium into a new conical tube. Mix well with 1.0-3.0 ml liquefied semen.

Centrifuge the tube at 300-400x g for 10 minutes

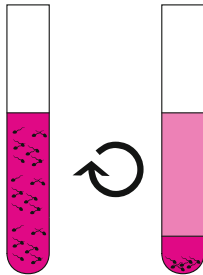

Swim-Up

Aspirate the supernatant without dispersing the pellet and discard it.

Carefully overlay the pellet with equilibrated GM501 SpermActive or warmed GM501 SpermAir medium.

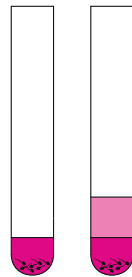

Put the tube in the CO₂-incubator (GM501 SpermActive). Or heating cabinet (GM501 SpermAir) for 1 hour with not firmly closed top.



Aspirate the supernatant containing the motile sperms and fill it into a new conical centrifuge tube.

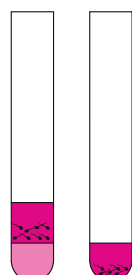

Washing 2

Resuspend the pellet with 1 ml equilibrated GM501 SpermActive or warmed GM501 SpermAir medium.

Centrifuge the tube at 300-400x g for 6 minutes.

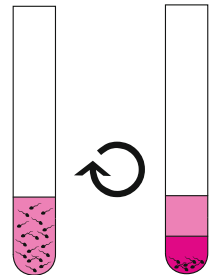

Aspirate the supernatant without dispersing the pellet and discard it.

Resuspend the pellet with 1 ml equilibrated GM501 SpermActive or warmed GM501 SpermAir medium. Centrifuge the tube at 300-400x g for 6 minutes.

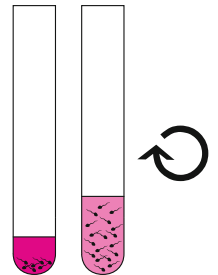

Repeat the step.

Aspirate the supernatant and discard it.

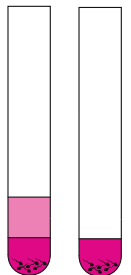

For IVF resuspend the pellet in 0.1-1.0 ml equilibrated culture medium (e.g. GM501 Cult) to the desired sperm concentration, for ICSI or Insemination resuspend it in GM501 SpermActive or GM501 SpermAir.



Swim-Up

Recommended application for direct Swim-Up

Preparation:

We recommend one of the products from the GM501 MediaLine:

- GM501 SpermAir or
- GM501 SpermActive

Swim-Up

To prepare the swim-up tubes, transfer 2 ml medium into a new conical tube.

Underlay gently 1 ml of liquefied semen.

Place the tube in the CO₂-incubator (GM501 SpermActive) or heating cabinet (GM501 SpermAir) for 1 hour with not firmly closed top.

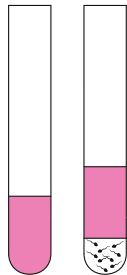

Aspirate the supernatant without dispersing the pellet and discard it.

Resuspend the pellet with 1 ml equilibrated GM501 SpermActive or warmed GM501 SpermAir medium.

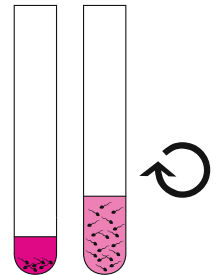

Centrifuge the tube at 300-400x g for 6 minutes.

Repeat the step.



Washing

Aspirate the upper media layer containing the motile sperms without dispersing the native ejaculate and fill it into a new conical centrifuge tube.

Aspirate the supernatant and discard it.

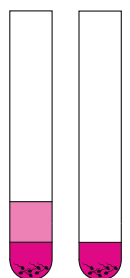

Centrifuge the tube at 300-400 g for 6 minutes.

For IVF resuspend the pellet in 0.1-1 ml equilibrated culture medium (e.g. GM501 Cult) to the desired sperm concentration, for ICSI or Insemination resuspend it in GM501 SpermActive or GM501 SpermAir.

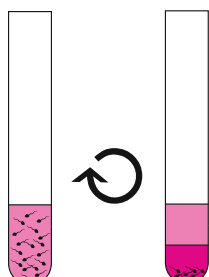

Density centrifugation

GM501 Gradient - Recommended application

Preparation

Before use warm all components of the system and the samples to 37°C or to room temperature.

Mix the density gradient bottles by minimum 5 bottles inversions before use.

Pipet 2.5 ml of the lower density gradient (e.g. 45%) into a sterile disposable centrifuge tube.



Using a syringe, resuspend the pellet with 2-3 ml of fresh washing medium.

Centrifuge at 300x g for 8-10 minutes.

In case you want to gain higher sperm concentrations it is advisable to centrifuge for the whole 10 minutes.

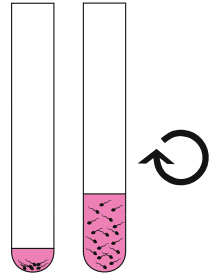

Using a 3 ml syringe with a 21 G needle, layer 2.5 ml of the higher density gradient (e.g. 90%) under the lower density gradient (e.g. 45%) free of air bubbles.



Take care that the two layers are distinctly separated. This is done by placing the tip of the needle at the bottom of the centrifuge tube and slowly dispensing the higher density gradient.

Aspirate the supernatant and repeat the last two steps.

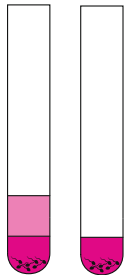

These two layers of density are stable for about two hours.

Gently place 2.5 ml of liquefied semen onto the upper layer using a transfer pipette or syringe.



Centrifuge at 350-400x g for 15-18 minutes.

Finally remove the remaining liquid to have the pellet resuspended again in the desired amount for the use with the subsequent procedure of assisted reproductive medicine (e.g. IVF, ICSI, IUI).



In case, no pellet is visible after this step, centrifuge for another 3 minutes.

Centrifugation force should not be increased over 500x g

Aspirate the supernatant.

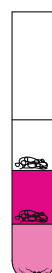

Insemination Kit

- **Ready-to-use**
- **Complete system for IUI**
- **Contains GM501 SpermAir**



Intended use

The Insemination Kit is a complete system for simple and safe preparation and processing of human spermatozoa out of the ejaculate, for homologous and heterologous intrauterine inseminations (IUI).

The Insemination Kit uses the self motility of the male germ cells to isolate motile spermatozoa in high concentrations. We recommend the use if the ejaculate is normozoospermic or slightly oligo- and/or asthenozoospermic.

One kit contains

- 1 x Vial with 2 ml of GM501 SpermAir medium (sterile)
- 2 x 2 ml syringes (sterile)
- 1 x short cannula (sterile)
- 2 x long cannulas (sterile)
- 1 x Insemination catheter standard or memo (sterile)
- 1 x Instructions for use
- 1 x Ampulla rack

Instructions for use

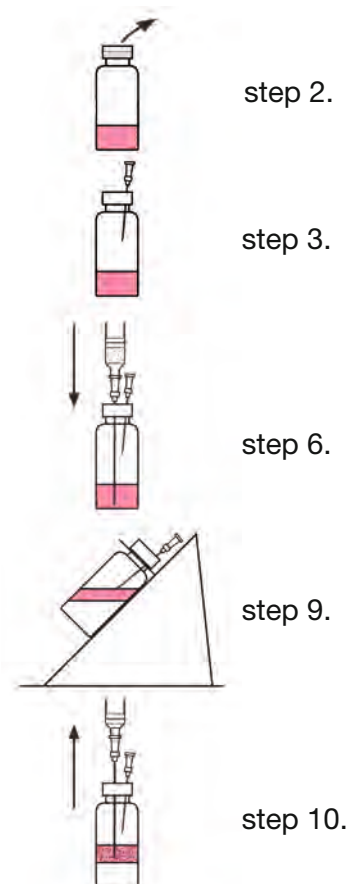

For further information see page 20.

Ref. No.	Size	Storage	Shelf life*
4SA-KIT-002-standard	1 x kit	2 -8°C	6 months
4SA-KIT-002-memo	1 x kit	2 -8°C	6 months

Insemination Kit

Recommended application

1. Warm up the GM501 SpermAir vial to 37°C.
2. Remove metal cap from the stopper and disinfect the stopper's surface with isopropylalcohol (70%).
3. Insert the enclosed short cannula through the stopper. It serves as pressure balance valve.
4. Aspirate liquefied, analysed ejaculate into an enclosed 2 ml syringe and attach a long cannula.
5. Hold the syringe with its tip upwards to collect air in the upper part of the syringe and press it out.
6. Insert the syringe's cannula (tip downwards) through the vial's stopper until the tip attaches the bottom of the vial.
7. Now release the ejaculate slowly and carefully by pressing it out of the syringe and let it suspend under the preparation medium without mixing the two liquids.
8. After deflation remove the syringe with the cannula carefully while leading the tip along the inner wall of the vial. Discard the syringe and the cannula.
9. Now carefully place the vial's neck into the rack's fork and store the vial at 37°C in a incubator (no CO₂)/ warming cabinet for least 45 minute and not longer than 3 hours.
10. After the time carefully take the vial out and turn it upright. Attach a fresh long cannula on the tip of a fresh 2 ml syringe and insert it again through the disinfected stopper.
11. Aspirate 0.5 to 1.0 ml of the upper media layer and remove the syringe with the cannula. The syringe now contains the SpermAir fraction with the isolated motile sperms. Until the insemination procedure place the syringe with the cannula with the attached protection cap of the cannula in a incubator (no CO₂)/ warming cabinet at 37°C.
12. To inseminate remove the cannula from the syringe and attach the enclosed IUI-catheter at the tip of the syringe. Previous to the filling with the suspension 1 ml air is being aspirated into the syringe, so it is assured that the total probe will be spend during insemination into the cavum uteri. (Dead air volume of the catheter 1.3 mm³).
13. The position assistance is adjusted corresponding to the anatomical proportions determined before.
14. The catheter is inserted until the assistance is position on the outer uterine orifice.
15. As soon as the requested position has been reached, the catheter will be turned, so that the marks on the grip are lying visible on top. In this way both of the lateral openings at the very end of the catheter are lined up towards the applicators orifice.
16. The suspension with the spermatozoa is injected slowly into the cave uteri.
17. Finally the catheter is slowly being extracted out of the uterus.

Advice

If the sperm is not liquefied sufficiently 30 minutes after the ejaculation, liquefy it by aspirating it into a sterile disposable syringe (2 or 5 ml) and flushing it out several times.

Before doing this, let disturbing rude particles sediment and do not aspirate them into the syringe.

It is recommended to analyze the sperm concentration prior to the insemination. For the insemination at least 2 million grade A spermatozoa should be present. An insemination with lower than 0.5 million/ml motil spermatozoa is not recommended. If performed optimally, the sperm suspension contains no or just very few immotile spermatozoa.

Cryopreservation



GM501 EmbryoStore

- Ready-to-use
- Freezing and thawing of human embryos (2PN, 4-cell stage)
- Contains Propandiol and Sucrose
- Contains Human Serum Albumin
 - Embryo Freeze 15 g/liter
 - Embryo Thaw 1 14 g/liter
 - Embryo Thaw 2 14 g/liter
 - Embryo Thaw 3 14 g/liter
- CE marked class III (0344)



Intended use

GM501 EmbryoStore is a set of ready-to-use antibiotic free media for freezing and thawing of human embryos between 2PN and 4-cell stage.

Instructions for use

Ensure all media are mixed well and warmed up to room temperature before use.

For further information see page 25.

Composition

- NaCl, KCl, KH_2PO_4 , Na_2HPO_4
- Sucrose
- Propandiol
- Human Serum Albumin

Tested specifications

- pH
- Osmolality (EmbryoStore Thaw 3)
- Sterility
- Endotoxins
- MEA

Ref. No.	Size	Storage	Shelf life*
4 EMF01_P_KIT1	1 x Kit	2 - 8°C	18 months
4 EMF01_P_F	1 x 10 ml Freeze	2 - 8°C	18 months
4 EMF01_P_T1	1 x 10 ml Thaw 1	2 - 8°C	18 months
4 EMF01_P_T2	1 x 10 ml Thaw 2	2 - 8°C	18 months
4 EMF01_P_T3	1 x 10 ml Thaw 3	2 - 8°C	18 months

* from time of manufacture

GM501 VitriStore Freeze - GM501 VitriStore Thaw

- Ready-to-use
- Vitrification and thawing of human embryos
- Contains DMSO and Ethylene Glycol
- Contains Human Serum Albumin

Pre-vitrification	20 g/liter
Vitri Freeze 1	16 g/liter
Vitri Freeze 2	10 g/liter
Vitri Thaw 1	18 g/liter
Vitri Thaw 2	19 g/liter
Vitri Thaw 3	19 g/liter
Vitri Thaw 4	20 g/liter
- CE marked class III (0344)



Intended use

GM501 VitriStore Freeze/VitriStore Thaw are a set of ready-to-use antibiotic free media for vitrification and thawing of human embryos.

Composition

GM501 VitriStore Freeze

- NaCl, KCl, KH_2PO_4 , Na_2HPO_4
- Sucrose^{VSF1}
- DMSO^{VSF1,2}, Ethylene Glycol^{VSF1,2}, Ficoll^{VSF2}
- Human Serum Albumin

GM501 VitriStore Thaw

- NaCl, KCl, KH_2PO_4 , Na_2HPO_4
- Sucrose^{VST1,2,3}
- Human Serum Albumin

***Contained in the respective Freeze and Thaw media as active reagent.

Instructions for use

Ensure all media are well mixed before use. We strongly advice to read through all the steps of the vitrification/thawing procedure before starting the procedure.

For further information see page 26-27.

Tested specifications

- pH
- Osmolality
- Sterility
- Endotoxins
- MEA

References

- Stinshoff H., Wilkening S., Hanstedt A., Brüning K., Wrenzycki C. (2011): Cryopreservation affects the quality of in vitro produced bovine embryos at the molecular level. Theriogenology 76: 1433-1441

Ref. No.	Size	Storage	Shelf life*
4 VF_KIT1	1 x VitriStore Freeze Kit 1 x 5 ml Pre-vitrification Medium 1 x 1 ml Freeze Medium 1 1 x 1 ml Freeze Medium 2	2 - 8°C	12 months
4 VT_KIT1	1 x VitriStore Thaw Kit 1 x 5 ml Thaw Medium 1 1 x 1 ml Thaw Medium 2 1 x 1 ml Thaw Medium 3 1 x 1 ml Thaw Medium 4	2 - 8°C	12 months

GM501 GentleVit Freeze - GM501 GentleVit Thaw

- Ready-to-use
- Vitrification and warming of human oocytes and embryos
- Contains DMSO, Ethylene Glycol and Sucrose
- Contains Human Serum Albumin

GPI	20 g/liter	GT1	17 g/liter
GF1	20 g/liter	GT2	18 g/liter
GF2	20 g/liter	GT3	18 g/liter
GF3	18 g/liter	GT4	19 g/liter
GF4	18 g/liter	GT5	19 g/liter
GF5	10 g/liter	GT6	20 g/liter
- CE marked class III (0344)



Intended use

GM501 GentleVit Freeze/GentleVit Thaw are a set of ready-to-use media for vitrification and thawing of human oocytes and embryos.

Composition

GM501 GentleVit Freeze

- NaCl, KCl, CaCl₂, KH₂PO₄, MgSO₄
- Bicarbonate, HEPES
- Glucose, Lactate, Pyruvate, Sucrose^{GF5}, Ficoll^{GF5}
- DMSO^{GF1,2,3,4,5}, Ethylene Glycol^{GF1,2,3,4,5}
- Human Serum Albumin

GM501 GentleVit Thaw

- NaCl, KCl, KH₂PO₄, MgSO₄
- Bicarbonate, HEPES
- Sucrose^{GT1,2,3,4,5}, Glucose, Lactate, Pyruvate
- Human Serum Albumin

***Contained in the respective Freeze and Thaw media as active reagent.

Instructions for use

Ensure that all media bottles of the kit are well mixed before use and warmed to room temperature (~22°C). **One exception is Thaw Medium 1, which must be warmed to 37°C before use.** We strongly advise to read through all the steps of the vitrification/thawing procedure before starting the procedure.

For further information see page 28-29.

Tested specifications

- pH
- Osmolality
- Sterility
- Endotoxins
- MEA

Ref. No./Size

4 GVF_KIT1

1 x GentleVit Freeze Kit

- 1 x 5 ml Pre-vitrification Medium
- 1 x 1 ml Freeze Medium 1
- 1 x 1 ml Freeze Medium 2
- 1 x 1 ml Freeze Medium 3
- 1 x 1 ml Freeze Medium 4
- 1 x 1 ml Freeze Medium 5

Ref. No./Size

4 GVT_KIT1

1 x GentleVit Thaw Kit

- 1 x 5 ml Thaw Medium 1
- 1 x 1 ml Thaw Medium 2
- 1 x 1 ml Thaw Medium 3
- 1 x 1 ml Thaw Medium 4
- 1 x 1 ml Thaw Medium 5
- 1 x 1 ml Thaw Medium 6

Storage

2 - 8°C

Shelf life*

12 months

* from time of manufacture

GM501 SpermStore

- Ready-to-use
- HEPES buffered
- For freezing of human sperm (including epididymal and testicular sperm)
- Freezing 1.00 ml of semen with 0.70 ml of GM501 SpermStore
- Contains Glycerol and Sucrose
- Contains Human Serum Albumin (4.00 g/liter)
- CE marked class III (0344)



Intended use

GM501 SpermStore is a antibiotic free medium for freezing human spermatozoa including epididymal or testicular sperm.

Instructions for use

Ensure all media are mixed well and warmed up to room temperature before use.

For further information see page 30.

Composition

- NaCl, KCl, MgSO₄, NaH₂PO₄
- Bicarbonate, HEPES
- Glucose, Lactate, Sucrose
- Glycine
- Glycerol
- Human Serum Albumin

Tested specifications

- pH
- Sterility
- Endotoxins
- Sperm Survival Test

Ref. No.	Size	Storage	Shelf life*
4 SCP-20	1 x 20 ml	2 - 8°C	18 months

Slow freezing

GM501 EmbryoStore - Recommended application

Preparation

Ensure all media are warmed up to room temperature and mixed well before use.

Freezing

1. Using a sterile pipette place 1 ml of EmbryoStore Freeze medium in a centre well dish (at room temperature).
2. Add the embryos to the freezing medium and allow them to settle for about 30 seconds.

Caution: because of density differences the embryos tend to float upwards and shrink like raisins.

3. Load the embryos in straws leaving about 1/5 air in the straw.
4. Seal the straws and label with name, date and number of embryos.
5. Start freezing program within 5-10 minutes. Below is an example of a freezing protocol.

	Temperature range	Freezing rate	Time
Phase 1	RT to +4°C	-10°C/min	2 min
Phase 2	+4°C to -6°C	-2°C/min	5 min
Phase 3	-6°C (autoseeding)	0°C/min	10 min
Phase 4	-6°C to -30°C	-0,3°C/min	80 min
Phase 5	-30°C to -196°C	-199°C/min	1 min

Thawing

1. Place in a 4-well culture dish 1 ml of each EmbryoStore Thaw thawing solution (1, 2 & 3). This leaves 1 well empty to retrieve the frozen/thawed embryos.
2. Prepare a water bath at 37°C to thaw the straws. Prepare a 1 ml tuberculin-syringe by filling it with 0.8 ml of air first followed by 0.2 ml of EmbryoStore Thaw 1 medium.
3. Remove the straws from liquid nitrogen and leave at room temperature for about 5 seconds.
4. Submerge the straw in the water bath at 37°C for another 5 seconds (ensure no frozen part remains in the straw).
5. Empty the straw by opening both sides of the straw (above the empty well) and blowing the contents of the syringe through the straw.
6. Retrieve the embryos using a microscope and place them in EmbryoStore Thaw 1 thawing solution.
7. Transfer the embryos to EmbryoStore Thaw 2 thawing solution after 3-5 minutes.
8. After another 3-5 minutes the embryos are transferred to EmbryoStore Thaw 3 thawing solution. Leave for a further 3-5 minutes before proceeding.
9. At the final stage the embryos are transferred in IVF culture medium (e.g. GM501 Cult media) for washing and further culture.

Vitrification

GM501 VitriStore Freezing - Recommended application

Preparation

Ensure all media are warmed up to 37°C and mixed well before use.

We strongly advice to read through all the steps of the vitrification/thawing procedure before starting the procedure.

Preliminary steps

1. In a 4-well dish fill the first well with 300 µl of VitriStore Pre-vitrification Medium, the second with VitriStore Freeze 1 and the third with VitriStore Freeze 2 solution.
2. Make sure that the liquid nitrogen is available to ensure fast work flow.
3. Next open as many packs of vitrification devices as will be required for the vitrification step. Conveniently place the separate parts of the vitrification device on the workbench for easy access later in the procedure.

Freezing preparation

1. Transfer the embryos from the blastocyst cell culture medium into the first well (PVM).
2. Process the embryos according to the schemes by transferring them from one well to the next.

Vitrification

1. Using an attenuated pipette or an equally suitable device, deposit maximum 2 blastocysts in a volume of approximately 0.3 µl of VitriStore Freeze 2 on the tip of your vitrification straw.
2. Place the vitrification straw in the outer sheeth and seal it as indicated in the instructions for use of the vitrification device.
3. Plunge the sealed device into the liquid nitrogen.

Morulae

Early blastocysts

Blastocyst after artificial shrinking

Solutions and application at room temperature

well 1	well 2	well 3
PVM	VSF1	VSF2
2 min.	2 min.	30 sec.

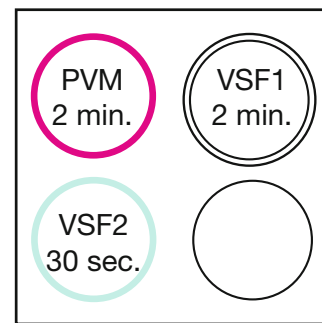

Blastocysts

Expanded blastocysts

Solutions and application at 37°C

well 1	well 2	well 3
PVM	VSF1	VSF2
2 min.	3 min.	30 sec.

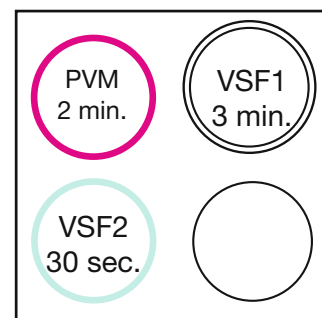

**Before starting the vitrification procedure, in order to reduce the negative effect of the blastocoel, expanded blastocysts should be collapsed by reducing the volume of the blastocoel artificially with a glass pipette. (Vanderzwalmen et. al., 2002; Sonet al., 2003; Hiraoka, 2004)*

Vitrification

GM501 VitriStore Thawing - Recommended application

Preparation

Ensure all media are warmed up to 37°C and mixed well before use.

We strongly advice to read through all the steps of the vitrification/thawing procedure before starting the procedure.

Thawing

1. Prepare the Media in the dishes well as depicted below.
2. Remove the vitrification straw from the outer sheath as indicated in the instructions for use of the vitrification device.
3. Immediately plunge the vitrification straw into pre-heated VitriStore Thaw Medium 1 (37°C) and leave in Thawing 1 medium for 3 minutes.
4. Transfer into VitriStore Thaw Medium 2 (37°C) and leave in this medium for 2 minutes.
5. Transfer into VitriStore Thaw Medium 3 (37°C) and leave in this medium for 2 minutes.
6. Finally transfer into VitriStore Thaw Medium 4 (37°C) and wash for at least 1 minute.
7. Transfer into blastocyst culture medium for continued cell culture (e.g. GM501 Cult media).

35 mm Petri dish	well 1	well 2	well 3
VST 1	VST 2	VST 3	VST 4
3 min.	2 min.	2 min.	1 min.

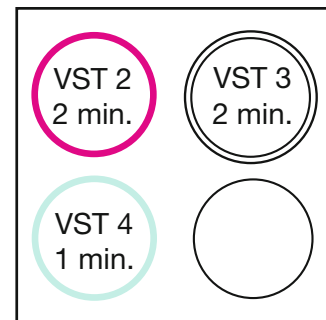

Vitrification and Thawing of Oocytes

GM501 GentleVit - Recommended application

Preparation for Vitrification

Ensure that all media bottles of the kit are well mixed before use and warmed to room temperature (~22°C). We strongly advice to read through all the steps of the vitrification/thawing procedure before starting the procedure.

Preliminary steps

1. In a 6-well dish, fill the first well with 250-300 µl of GentleVit Pre-vitrification medium, the second with Freeze Medium 1, the third with Freeze Medium 2 and continue doing so until Freeze Medium 5.
2. Open the necessary number of vitrification devices, taking into account that 1 device can hold 2-3 oocytes, in a maximum volume load of 1µl (check the instructions for the device you are using). Conveniently place the separate parts of the device on the workbench for easy access later in the procedure.

Vitrification protocol

Oocytes are sequentially exposed to the following media:

	GPI	GF1	GF2	GF3	GF4	GF5
DMSO/EG (%)	0	1.25	2.5	5	10	20
	2 min.	3 min.	3 min.	3 min.	5-6 min.	60 sec.* ¹

Preparation for Thawing

Ensure that all media bottles of the kit are well mixed before use and warmed to room temperature (~22°C). **One exception is Thaw Medium 1, which must be warmed to 37°C before use.** We strongly advice to read through all the steps of the vitrification/thawing procedure before starting the procedure.

Preliminary steps

1. In a 6-well dish, fill the first well with 250-300µl of Thaw Medium 1, the second with Thaw Medium 2, the third with Thaw Medium 3, and continue doing so until Thaw Medium 6.

Thawing protocol

Oocytes are sequentially exposed to the following media:

	GT1 (37°C)	GT2	GT3	GT4	GT5	GT6
Sucrose (M)	1	0.75	0.50	0.25	0.125	0
	1 min.	1 min.	1-2 min.	2 min.	2 min.	1-2 min.* ²

*¹ **Note:** The complete process of placing the oocyte in “Freeze Medium 5”, loading the oocyte on the vitrification device in maximum 1µl GF5, inserting the device in the outer straw and sealing should not take longer than 60 seconds before plunging the device into the liquid nitrogen.

Vitrification and Thawing of Embryos (Zygote to Blastocyst)

GM501 GentleVit - Recommended application

Preparation for Vitrification

Ensure that all media bottles of the kit are well mixed before use and warmed to room temperature (~22°C). We strongly advice to read through all the steps of the vitrification/thawing procedure before starting the procedure.

Preliminary steps

- For vitrification of embryos, the following media are **NOT** required:

GM501 GentleVit Freeze Medium 1

GM501 GentleVit Freeze Medium 2

- In a 6-well dish, fill the first well with 250-300µl of GentleVit Pre-vitrification medium, the second with Freeze Medium 3, the third with Freeze Medium 4 and the last with Freeze Medium 5.
- Open the necessary number of vitrification devices, taking into account that 1 device can hold 1-2 embryos in a maximum volume load of 1µl (check the instructions for the device you are using). Conveniently place the separate parts of the device on the workbench for easy access later in the procedure.

Vitrification protocol

Embryos are sequentially exposed to the following media:

	GPI	GF3	GF4	GF5
DMSO/EG (%)	0	5	10	20
Zygotes	2 min.	5 min.	5 min. 30 sec.	40-60 sec.* ¹
4-cell to blastocyst	2 min.	5 min.	4. min.	40-60 sec.* ¹

***²Note:** Wash for 1-2 min before transfer to culture medium.

Up to 5 vitrification cycles (of the same patient) can be performed with one media set-up. Do not use the same media for different patients!

Preparation for Thawing

Ensure that all media bottles of the kit are well mixed before use and warmed to room temperature (~22°C). **One exception is Thaw Medium 1, which must be warmed to 37°C before use.** We strongly advice to read through all the steps of the vitrification/thawing procedure before starting the procedure.

Preliminary steps

- For thawing of 4-cell embryos till blastocyst, the following media are **NOT** required:

GM501 GentleVit Thaw Medium 5

- In a 6-well dish, fill the first well with 250-300µl of Thaw Medium 1, the second with Thaw Medium 2, the third with Thaw Medium 3, the fourth with Thaw Medium 4, the fifth with Thaw Medium 5 (only for zygotes) and the last with Thaw Medium 6.

Thawing protocol

Embryos are sequentially exposed to the following media:

	GT1 (37°C)	GT2	GT3	GT4	GT5	GT6
Sucrose (M)	1	0.75	0.50	0.25	0.125	0
Zygotes	1 min.	1 min.	1 min.	2 min.	2 min.	1-2 min.* ²
4-cell to blastocyst	1 min.	1 min.	1-2 min.	2 min.		1-2 min.* ²

Sperm freezing

GM501 SpermStore - Recommended application

Preparation

Ensure all media are warmed up to room temperature and mixed well before use.

Before freezing

In case of very low sperm concentrations it is advisable to concentrate the sperm before freezing. GM501 Gradient can be applied before freezing to remove debris and to enrich the concentration of motile cells in a sample. This may increase sperm quality after thawing and will reduce the number of straws to be frozen.

Freezing

1. Allow the semen to liquefy at room temperature for 30 minutes.
2. Mix 1.00 ml of sperm with 0.70 ml GM501 SpermStore. Add the medium in drops while gently swirling.
3. Leave the mixture for 10 minutes at room temperature for equilibration.
4. Aspirate the sample/medium mixture into the freezing straws, leaving approximately 1.5 cm of air at the end of the straws.
5. Seal the straws.
6. Dry off individually with a lint-free wipe.
7. Shake to move the air-bubble to the centre of the straw.
8. Place the straw horizontally on a styrofoam board in a liquid nitrogen bath to allow for freezing in vapour phase. Leave for (at last) 15 minutes.
9. Transfer straws quickly into liquid nitrogen and store at -196°C .

Thawing

1. Remove as many straws as required from the liquid nitrogen.
2. Place the samples in tap water for 5 minutes.
3. Cut off the end of the straw, place the open end inside a container (e.g. a test tube) and tap the straw lightly against the side of the container to allow complete evacuation of the mixture.
4. Dilute the thawed sperm in a suitable insemination medium (at least 3.0 ml per 0.5 ml semen) and mix thoroughly.
5. Centrifuge for 15 minutes at 300-350x g.
6. Resuspend pellet in a suitable insemination medium.

After thawing

If necessary, use sperm preparation techniques after thawing the semen to eliminate dead sperm cells and debris.

Inovations in Laser & Imaging Technologies



LYCOS
Clinical Laser



ZANDAIR™
Air Purification System

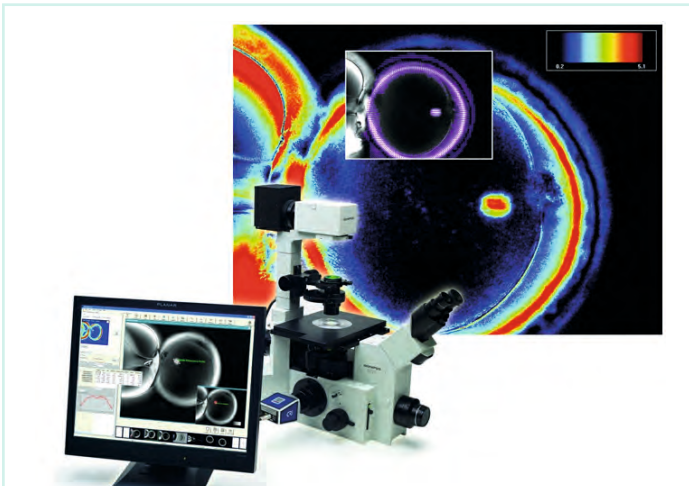

Oosight
Imaging System

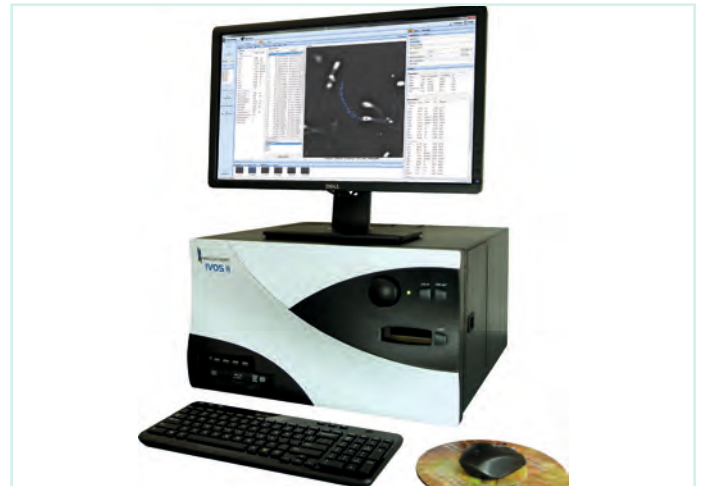

IVOS II
Sperm Analyzer



IMSI Strict™

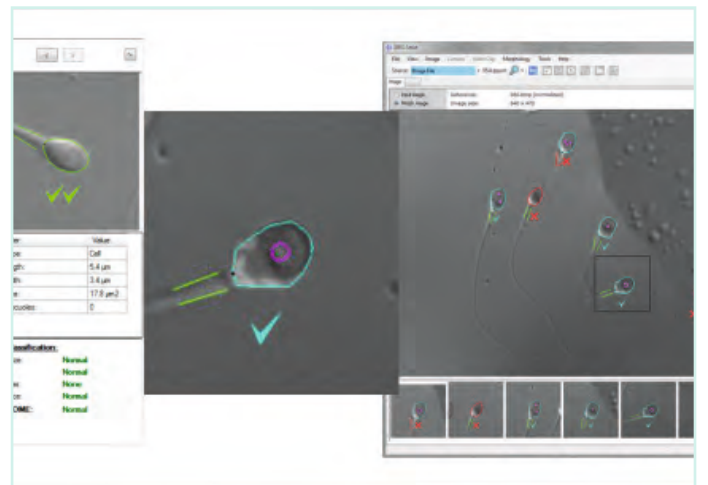

DNA Fragmentation Software

Enzymes Miscellaneous In-Vitro-Diagnostics



Bromelain in Dulbecco's PBS

- Ready-to-use
- For liquefaction of viscous semen samples
- Contains 10 IU/ml Bromelain
- Formulated according to WHO laboratory manual for the Examination and processing of human semen - Fifth edition
- CE marked class IIb (0482)



Intended use

Bromelain in Dulbecco's PBS is designed for liquefaction of viscous semen samples prior to semen analysis and preparation for further IVF treatment.

Composition

- NaCl, KCl, KH_2PO_4 , MgSO_4 , CaCl_2 , Na_2HPO_4
- Glucose
- Bromelain

Instructions for use

Warm the Bromelain in Dulbecco's PBS to 37°C.

For further information see page 34.

Tested specifications

- pH
- Osmolality
- Sterility
- Endotoxins
- MEA
- Sperm Survival Test

References

- Krebs T., Sollmann K., Maas D.H.A., Saymé N. (2012): Bromelase - A new way to reduce viscosity of human semen. 45th annual conference of Physiology and Reproduction and 37th Veterinary & Human Medicine conference in Berlin
- WHO laboratory manual for the Examination and processing of human semen (2010), 5th ed.: 14.

Ref. No.	Size	Storage	Shelf life*
4 GM 501BROM10	1 x 10 ml	2 - 8°C	6 months

* from time of manufacture

GM501 Collagenase

- Ready-to-use
- HEPES buffered
- Digestion of human testicular tissue obtained by biopsy
- Facilitates isolation of sperm cells from TESE digestion
- Contains 1000 CDU/ml (Collagen Digestive Units)
- Contains Human Serum Albumin (5.00 g/liter)



Intended use

GM501 Collagenase is a reagent for the digestion of human testicular tissue obtained by testicular biopsy (TESE) for in-vitro examination procedures. Using Collagenase, it is possible to degrade testicular tissue in single cells to facilitate the isolation of sperm cells.

Composition

- NaCl, KCl, KH_2PO_4 , MgSO_4 , CaCl_2
- Bicarbonate, HEPES, EDTA
- Glucose, Lactate, Pyruvate
- Non-essential and essential Amino Acids, Alanine-Glutamine
- Human Serum Albumin, Gentamicin, Phenolred
- Collagenase (obtained from culture filtrates of *Clostridium histolyticum*)

Can be used in combination with

- GM501 SpermAir
- GM501 SpermActive

Instructions for use

Do not equilibrate GM501 Collagenase in a CO_2 -incubator, just warm it up to 37°C . GM501 Collagenase is HEPES buffered. Incubation in a CO_2 -incubator will lower the pH.

For further information see page 35.

Tested specifications

- pH
- Osmolality
- Sterility

Performing LAL-endotoxin- and MEA-tests is not possible with this medium as the activity of the Collagenase inactivates the enzymes (LAL) and damages the mouse embryos (MEA), which are used for these assays, respectively. The basic medium is LAL- and MEA-tested.

References

- Wöber M., Ebner T., Steiner S. L., Strohm H., Oppelt P., Plas E., Obruca A. (2015) : A new method to process testicular sperm: combining enzymatic digestion, accumulation of spermatozoa, and stimulation of motility. Arch Gynecol Obstet 291:689-694

Ref. No.	Size	Storage	Shelf life*
4 COLL_AIR	1 x 3 ml	2 - 8°C	9 months

GM501 HSA

- For individual supplementation of media used in assisted reproduction
- Contains Human Serum Albumin (100.00 g/liter)



Intended use

GM501 HSA is intended for use in assisted reproductive procedures which include gamete and embryo manipulation. These procedures include the use of GM501 HSA solution as a supplement for culture medium.

Composition

- Human Serum Albumin in saline buffer (100.00 mg/ml)

Can be used in combination with

- GM501 Basic
- GM501 Gradient

Instructions for use

To supplement the 50 ml culture medium (e.g. GM501 Basic) with GM501 HSA to a protein end concentration of 1%. Keep 45 ml culture medium in the bottle and add 5 ml of GM501 HSA. Mix well.

Tested specifications

- pH
- Osmolality
- Sterility
- Endotoxins
- MEA

Ref. No.	Size	Storage	Shelf life*
4 HSA 0005	1 x 5 ml	2 - 8°C	12 months

* from time of manufacture

Liquefaction

Bromelain in Dulbecco's PBS - Recommended application

1. Warm the Bromelain in Dulbecco's PBS to 37°C.
2. Dilute the semen sample with the same volume of Bromelain (*for highly viscous, tenacious ejaculates we recommend to previously grind the ejaculate roughly!*).
3. Swing the semen solution carefully.
4. Incubate the ejaculate for approx. 10 minutes at 37°C.
5. Use the liquefied semen sample for evaluation.

Attention: To calculate the sperm cells concentration the dilution 1+1 (1:2) of semen with Bromelain must be accounted.

WHO laboratory manual-quote: These treatments may affect seminal plasma biochemistry, sperm motility and sperm morphology, and their use must be recorded.

6. Continue IVF treatment according to internal standard procedures.

Collagenase treatment

Recommended application

1. Extract 1.50 ml GM501 Collagenase out of original bottle and fill into a round bottom tube and warm to 37°C.
2. For digestion of testicular tissue carefully pick the chosen tissue pieces with a fine cannula. For easier handling fill the tissue suspension into a 60 mm petri dish. Let adhesive transport or cryo medium drop off as much as possible and transfer into Collagenase tube.
3. Close the tube completely. Now put the tube for 60 minutes in the incubator or in a heat cabinet for 37°C digestion of the tissue.
4. Suspend the digested tissue by carefully pipetting up and down. Under ideal conditions a suspension of single testicular tissue cells and free semen cells has been formed. If coarse tissue pieces are still visible. Incubate of additional 20 - 30 minutes.
5. Now centrifuge the tissue cell suspension and wash twice with 1 - 2 ml HEPES buffered sperm processing medium. Discard the obtained supernatants.
6. After the last centrifugation re-suspend the pellet in a small volume of 30 - 80 µl HEPES buffered sperm processing medium. Add a few µl of this suspension into the evaluation dish.
7. Control by microscope whether viable semen cells are present. If not, digest further tissue sample for diagnostic evaluation.
8. If no motile sperms can be found Gynemed recommends the application of GM501 Sperm-Mobil.

GM501 SpermMobil

- HEPES and bicarbonate buffered
- Dilute 1:20 with sperm processing medium
- For in-vitro examination of necrozoospermic ejaculates and immotile spermatozoa isolated from testicular tissue
- Contains Theophylline
- CE marked IVD



Intended use

GM501 SpermMobil is a HEPES buffered HSA free reagent containing low bicarbonate. It is used for in-vitro examination of sperm cells of necrozoospermic ejaculates as well as of immotile sperms isolated from testicular tissue (TESE).

Composition

- NaCl, KCl, KH_2PO_4 , MgSO_4 , CaCl_2
- Bicarbonate, HEPES, EDTA
- Glucose, Lactate, Pyruvate
- Non-essential and essential Amino Acids, Alanine-Glutamine
- Theophylline, Phenolred

Tested specifications

- pH
- Osmolality
- Sterility
- Endotoxins
- Sperm Survival Test

Can be used in combination with

- GM501 SpermAir
- GM501 SpermActive

Instructions for use

Do not equilibrate GM501 SpermMobil in a CO_2 -incubator, just warm it up to 37°C . GM501 SpermMobil is HEPES buffered. Incubation in a CO_2 -incubator will lower the pH.

For further information see page 38.

References

- Wöber M., Ebner T., Steiner S. L., Strohmmer H., Oppelt P., Plas E., Obruca A. (2015) : A new method to process testicular sperm: combining enzymatic digestion, accumulation of spermatozoa, and stimulation of motility. Arch Gynecol Obstet 291:689-694
- Ebner T., Shebl O., Mayer RB., Moser M., Costamoling W., Oppelt P. (2014): Healthy live birth using theophylline in a case of retrograde ejaculation and absolute asthenozoospermia. Fertil Steril 101:240-343
- Ebner T., Tews G., Mayer RB., Ziehr S., Arzt W., Costamoling W., Shebl O. (2011): Pharmacological stimulation of sperm motility in frozen and thawed testicular sperm using the dimethylxanthine theophylline. Fertil Steril 96: 1331-1336

Ref. No.	Size	Storage	Shelf life*
4 GM 501SMOBIL5	1 x 5 ml	2 - 8°C	6 months
4 GM 501SMOBIL5-S	1 x 1 ml	2 - 8°C	6 months

GM508 CultActive

- Ready-to-use
- Bicarbonate buffered
- Investigation of fertilization failure (oocyte activation)
- Contains Ca²⁺-Ionophore A23187
- CE marked IVD



Intended use

GM508 CultActive is a bicarbonate buffered HSA free reagent designed to investigate oocytes of patients with failed fertilization after previous intracytoplasmic sperm injection cycles.

GM508 CultActive is designed to investigate if fertilization failure after previous ICSI cycles is due to a deficient oocyte activation.

Composition

- NaCl, KCl, KH₂PO₄, MgSO₄, CaCl₂
- Bicarbonate, EDTA
- Glucose, Lactate, Pyruvate
- Non-essential and essential Amino Acids, Alanine-Glutamine,
- Ca²⁺-Ionophore A23187, DMSO

Tested specifications

- pH
- Osmolality
- Sterility
- Endotoxins
- MEA

can be used in combination with

- GM501 Cult media

Instructions for use

GM508 CultActive must be equilibrated 4 hours in vial not firmly closed at 5 - 7% CO₂ and 37°C prior to use. *For further information see page 39.*

References

- Ebner T., Maurer M., Oppelt P., Mayer R.B., Duba HC., Costamoling W., Shebl O.: Healthy twin live-birth after ionophore treatment in case of theophylline-resistant Kartagener syndrome. JARG (2015)
- Ebner T., Bulfon-Vogel S., Gruber I., Sonnenleitner U., Wöber M., Staples P., Shebl O., Mayer R.B., Oppelt P. (2014): Successful treatment with Ca²⁺-ionophore in case of previous developmental problems: a multicentre study. ESHRE P-148.
- Ebner T., Montag M. (2014): Live birth after artificial oocyte activation using a ready-to-use ionophore: a prospective multicentre study. Reproductive BioMedicine Online 11.012
- Ebner T., Montag M. (2011): Application of a ready-to-use ionophore increases rates of fertilization and pregnancy in severe male factor infertility. Fertil Steril 96: 34.
- Montag M., Ebner T. (2011): Clinical application of artificial oocyte activation: Result of a prospective multicenter study. Hum Reprod volume 26, Supplement 1 2011: Abstract Book: i106.

Ref. No.	Size	Storage	Shelf life*
4 GM 508CULT-active1	1 x 1ml	2 - 8°C	6 months

* from time of manufacture

GM501 SpermMobil

Recommended application

1. Do not equilibrate GM501 SpermMobil in a CO₂-incubator, just warm up to 37°C.
2. To facilitate sperm activation add 1.50 - 2.00 µl GM501 SpermMobil to the sperm cells containing drop (approx. 30.00 - 40.00 µl/dilution 1:20) of processing media inside the petri dish.
3. GM501 SpermMobil should be added to the opposing side from where the sperm cells are to be aspirated.
4. Wait for 10 minutes. The activating effect initiates after a few minutes and lasts approximately for one hour.
5. The dish should be placed on a heating plate at 37°C during the diagnostic evaluation.

GM508 CultActive

Recommended application

1. GM508 CultActive must be shaken directly before use for approximately 30 sec.
2. GM508 CultActive must be equilibrated 4 hours in a vial not firmly closed at 5 - 7% CO₂ and 37°C prior to use.
3. Equilibrate culture medium for washing (e.g. GM501 Cult) for 4 hours in a vial not firmly closed at 5 - 7% CO₂ and 37°C prior to use.
4. Prepare for each oocyte 1 drop (30.00 µl) GM508 CultActive and 2 drops (30.00 - 50.00 µl) culture medium MOPS and HEPES free, (e.g. GM501 Cult). An oil overlay of the drops using suitable oil (e.g. GM501 Mineral Oil) is recommended. Please be aware that protein-free media drops (e.g. GM508 CultActive) can exhibit slightly different dynamic properties compared to other media.
5. Immediately after the ICSI procedure incubate the oocytes for 15 minutes in the pre-equilibrated Ca²⁺-ionophore GM508 CultActive drops. (See picture below - Step 1 - Activation)
6. Remove the oocytes from the GM508 CultActive drop and wash twice in culture media. This has to be done in a HEPES or MOPS free media, e.g. GM501 Cult media. (See picture below - step 1 and 2 - washing)
7. Put the oocytes in your culture medium for further culture.
8. Assess the development on select time points.

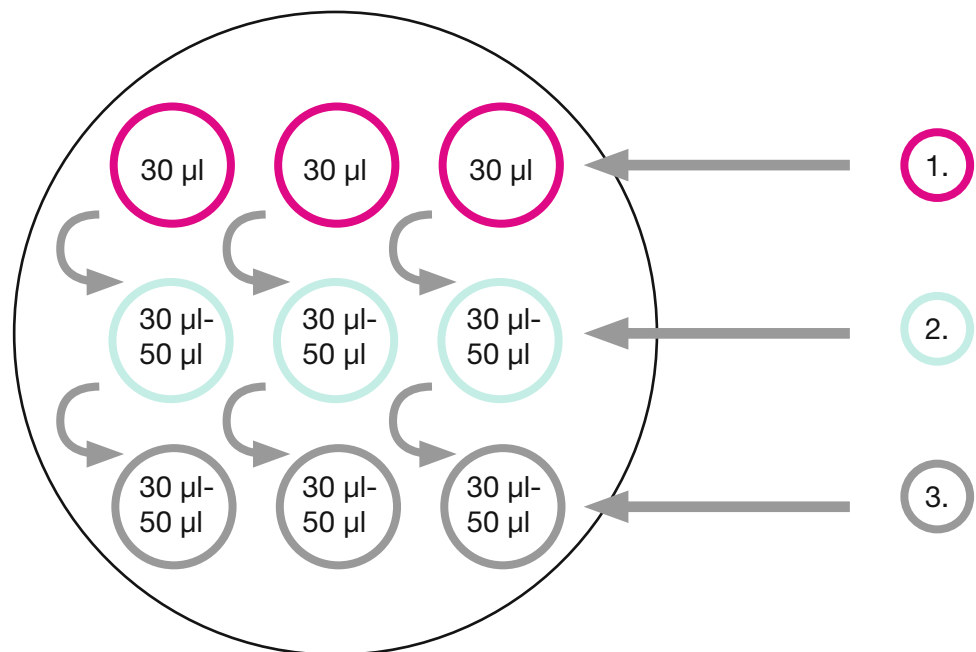

1. Activation - GM508 CultActive - 30 µl

2. Washing Step 1 - e.g. GM501 Cult - 30-50 µl

3. Washing Step 2 - e.g. GM501 Cult - 30-50 µl

Semen - Diagnostics

SemenMar - SemenIgG - SemenIgA

SemenMar

- Ready-to-use
- Detection of anti-sperm-antibodies (ASA)
- Indicates presence of IgG and/or IgA-antibodies on motile sperm cells
- Detection with Anti-IgG and Anti-IgA-coated yellow microspheres
- CE marked IVD



SemenIgG

- Ready-to-use
- Detection of anti-sperm-antibodies (ASA)
- Indicates presence of immunoglobulin G (IgG)-type antibodies on motile sperm cells
- Detection with Anti-IgG-coated blue microspheres
- CE marked IVD



SemenIgA

- Ready-to-use
- Detection of anti-sperm-antibodies (ASA)
- Indicates presence of immunoglobulin A (IgA)-type antibodies on motile sperm cells
- Detection with Anti-IgA-coated red microspheres
- CE marked IVD



Ref. No.	Size	Storage	Shelf life*
ZR11200-IgA	1 x 300 µl	2 - 8°C	18 months
ZR11400-IgG	1 x 300 µl	2 - 8°C	18 months
ZR11100-Mar	1 x 300 µl	2 - 8°C	18 months

Semen - Diagnostics

SemenStain - SemenVIT - SemenHos

SemenStain

- Morphology assessment of spermatozoa
- Succedan-staining method
- Differential staining of spermatozoa tissues based on their basophilic, eosinophilic and neutrophilic properties
- CE marked IVD



SemenVIT

- Vitality assessment of spermatozoa
- Dye exclusion method
- Based on the integrity of the sperm membrane in live spermatozoa
- CE marked IVD



SemenHos

- Vitality assessment of spermatozoa
- Hypoosmotic swelling method
- Based on the semi-permeability of the intact cell membrane and the possibility of active water transport
- Swelling effect in intact-sperm cells can be observed for up to 30 min
- CE marked IVD



Ref. No.	Size	Storage	Shelf life*
ZR10050-Stain	1 x 50 ml Reagenz 1 1 x 50 ml Reagenz 2 1 x 50 ml Reagenz 3 1 x 50 ml Reagenz 4	15 - 25°C	36 months
ZR10300-VIT	1 x 20 ml Reagenz 1 1 x 30 ml Reagenz 2	2 - 8°C	24 months
ZR106020-Hos	20 x 900 µl	2 - 8°C	24 months

* from time of manufacture

Pipettes



Holding micropipettes

- Sterile
- 3 years shelf life
- Individually packed
- Customized production of pipettes available on request
- Mouse Embryo Tested
- CE marked (2265)



Intended use

Holding micropipettes are used for the fixation of oocytes, embryos or blastocysts and are therefore essential for all micromanipulation procedures in ART like ICSI, assisted hatching and polar body or blastomere biopsy.

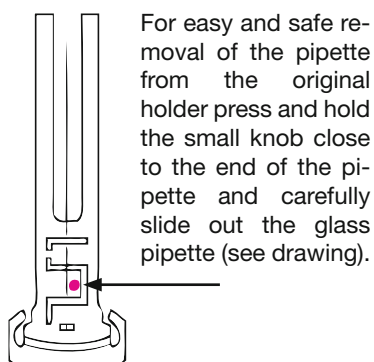
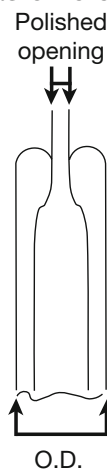

Specification and quality control

- To meet international standards as well as the requirements of the FDA, the Holding micropipettes are sterilized by gamma radiation.
- The Holding micropipettes are prepared from borosilicate glass tubing.
- Outer diameter 1.00 mm, inner diameter 0.75 mm, total length 5.50 cm, polished opening, length arm 0.9 mm, bending angle 20°-40°.
- The micropipettes are available straight or with bending angle.
- A Mouse Embryo Test (MEA) is available for each batch upon request from our website with respective lot number.

Product code	Code	O.D. μm	Angle	Polished opening μm	Box- pcs.
small O.D.					
code + O.D. + angle (Example 001-80-20)	001	80	20°, 30°, 35°, 40° or straight	15	20
medium O.D.					
code + O.D. + angle (Example 001-100-20)	001	100	20°, 30°, 35°, 40° or straight	20	20
large O.D.					
code + O.D. + angle (Example 001-120-20)	001	120	20°, 30°, 35°, 40° or straight	25	20

Injection micropipettes

- Sterile
- 3 years shelf life
- Individually packed
- Customized production of pipettes available on request
- Mouse Embryo Tested
- CE marked (2265)



Intended use

ICSI (intracytoplasmic Sperm Injection) micropipettes are used to aspirate and inject the sperm directly into the oocyte.

Large ICSI-Spermatid micropipettes are used for aspiration and injecting immature sperm directly into the oocyte. ICSI-Spermatid micropipettes have I.D. 7.00 - 8.00 μm , O.D. 9.00 - 10.00 μm of the tip.

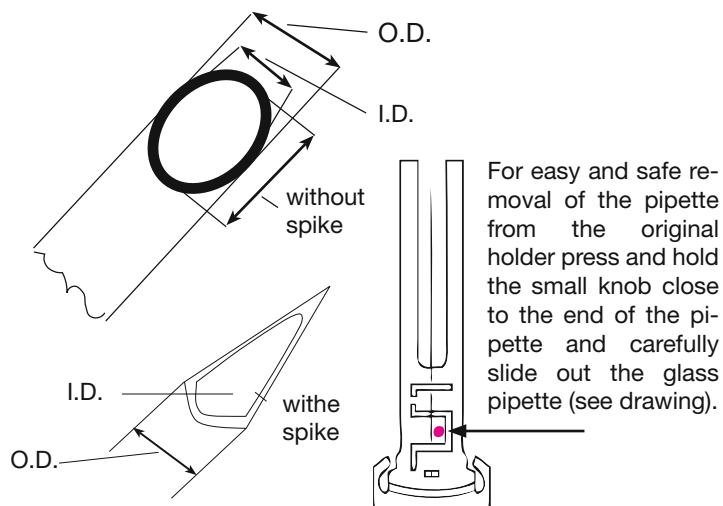

Specification and quality control

- To meet international standards as well as the requirements of the FDA, the ICSI micropipettes are sterilised by gamma radiation.
- The ICSI micropipettes are prepared from borosilicate glass tubing
- Outer diameter 1.00 mm, inner diameter 0.78 mm, total length 5.50 cm, bending angle 20°-35° with length of arm 0.90 mm, beveled 35°, with inner diameter of the tip 4.50 - 5.00 μm .
- The micropipettes are made with or without spike, straight or with bending angle and beveled 30°-40°.
- A Mouse Embryo Test (MEA) is available for each batch upon request from our website with respective lot number.

Product code	Code	I.D. μm	Angle	Spike (s)	Box- pcs.
ICSI micropipettes					
code + I.D. + angle + spike (Example 002-5-20-s)	002	5	20°, 30°, 35° or straight	with or without	20
Large ICSI-Spermatid micropipettes					
code + I.D. + angle + spike (Example 002-7-20-s)	002	7	20°, 30°, 35° or straight	with or without	20

Hatching micropipettes

- Sterile
- 3 years shelf life
- Individually packed
- Customized production of pipettes available on request
- Mouse Embryo Tested
- CE marked (2265)



Intended use

Hatching micropipettes are used for the mechanical opening of the Zona pellucida of embryos or blastocysts by partial zona dissection (mechanical assisted hatching).

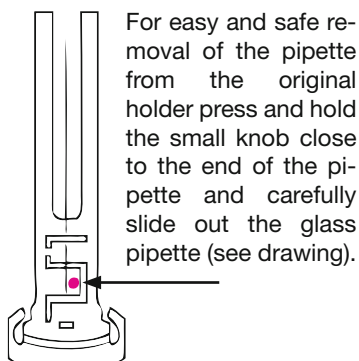
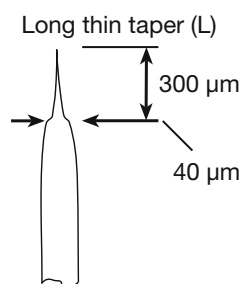
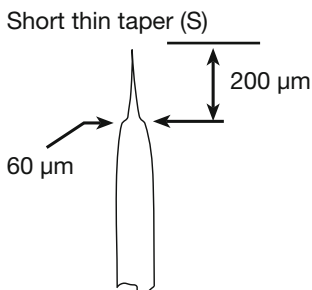

Specification and quality control

- To meet international standards as well as the requirements of the FDA, the Hatching micropipettes are sterilised by gamma radiation.
- The Hatching micropipettes are prepared from borosilicate glass tubing.
- outer diameter 1.20 mm, total length 5.50 cm, bending angle 20° - 45°, length of the arm 1.00 mm with short thin taper (S) or with long thin taper (L), sharp point.
- Hatching micropipettes may be ordered straight or with bending angle.
- A Mouse Embryo Test (MEA) is available for each batch upon request from our website with respective lot number.

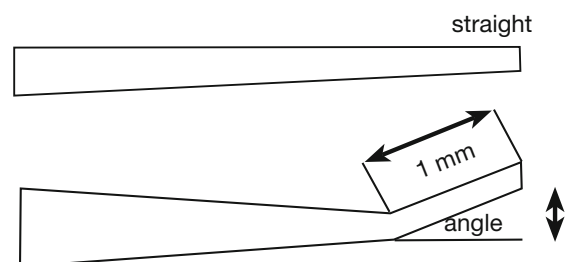

Product code	Code	Angle	Taper	Box-pcs.
Short thin taper				
code + angle + taper (Example 003-20-S)	003	20°, 30°, 35° or straight	short (S)	20
Long thin taper				
code + angle + taper (Example 003-20-L)	003	20°, 30°, 35° or straight	long (L)	20

Biopsy micropipettes

- Sterile
- 3 years shelf life
- Individually packed
- Customized production of pipettes available on request
- Mouse Embryo Tested
- CE marked (2265)



Intended use

Biopsy micropipettes are used to perform biopsies on the embryo (blastocyst) or the oocyte (polar body) for Preimplantation Genetic Diagnosis - PGD.

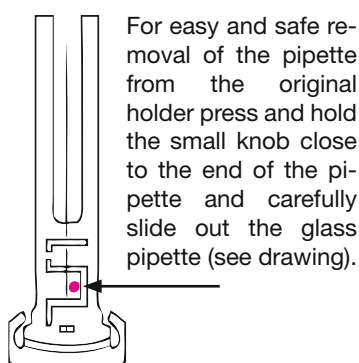
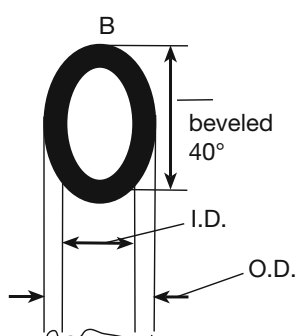
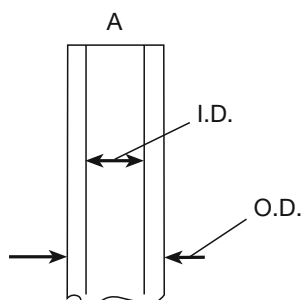

Specification and quality control

- To meet international standards as well as the requirements of the FDA, the Biopsy micropipettes are sterilised by gamma radiation.
- The Biopsy micropipettes are prepared from borosilicate glass tubing.
- Outer diameter 1.00 mm, inner diameter 0.78 mm, total length 5.50 cm, bending angle 20°-45°, length of the arm 0.50 mm, with blunt opening (A) or beveled 40° and polished (B) and with inner diameter 10, 15, 20, 30 and 35 µm.
- Biopsy micropipettes may be ordered straight or with bending angle.
- A Mouse Embryo Test (MEA) is available for each batch upon request from our website with respective lot number.

Product code	Code	I.D. µm	Angle	Opening	Box-pcs.
A (blunt)					
code + I.D. + angle + blunt opening (Example 004-10-30-A)	004	10, 15, 30, 35	30°, 35° or straight	A (blunt)	20
B (beveled)					
code + I.D. + angle + beveled opening (Example 004-10-30-B)	004	10, 15, 30, 35	30°, 35° or straight	B (beveled)	20

Denuding micropipettes

- Sterile
- 3 years shelf life
- Individually packed of 4
- Customized production of pipettes available on request
- Mouse Embryo Tested
- CE marked (2265)



Intended use

Denuding micropipettes are used for oocyte denudation or gamete and embryo handling.

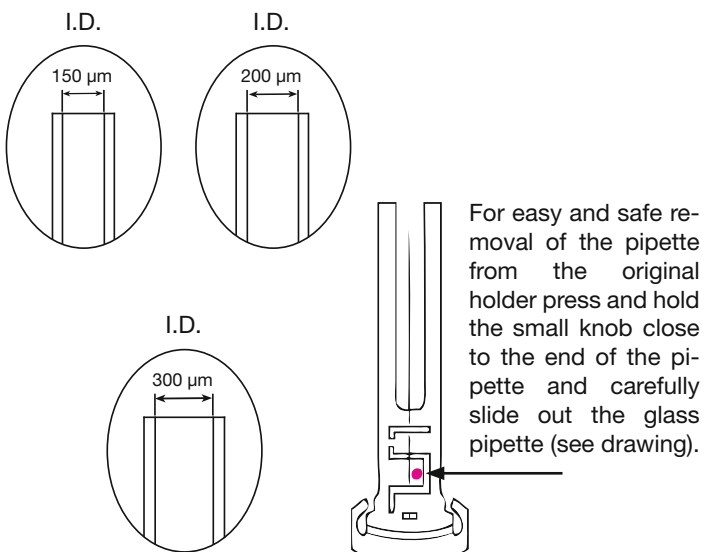

Specification and quality control

- To meet international standards as well as the requirements of the FDA, the Denuding micropipettes are sterilised by gamma radiation.
- The Denuding micropipettes are prepared from borosilicate glass tubing.
- Outer diameter 1.20 mm, inner diameter 0.75 mm, total length 9.50 cm have a blunt opening and are sold straight.
- A Mouse Embryo Test (MEA) is available for each batch upon request from our website with respective lot number.

Product code	Code	I.D. µm	Box pcs.
White			
code + I.D. -C (Example 005-120-C)	005	120, 150	40
Grey			
code + I.D. -B (Example 005-180-B)	005	180, 200	40
Brown			
code + I.D. -A (Example 005-250-A)	005	250, 300	40

DENU-Tips

- Made out of Polyamid
- Singly and sterile packed of 20
- Sterilized for 3 years
- Different sizes available
- Mouse-Embryo-tested
- CE marked (Class IIa)



Intended use

The DENU-Tips are used for the manipulation and transfer of oocytes and embryos during IVF/ ICSI procedures.

Specification and quality control

- Considered to be Bisphenol A (BPA) free.
- The DENU-Tips are available in a variety of sizes with inner diameter from 135 μm to 300 μm . For easy differentiation, each size is color-coded.
- A Mouse Embryo Test (MEA) result is available for each lot number upon request from our website.

The DENU-Tips are ordered by supplying the Code (GY), Inner Diameter size and Number of Tips in Box (20 or 200) as shown below.

CODE	I.D. SIZE (color)	BOX of 20	BOX of 200
GY	135 (yellow)	GY-135/20	GY-135/200
GY	140 (white)	GY-140/20	GY-140/200
GY	150 (green)	GY-150/20	GY-150/200
GY	155 (green)	GY-155/20	GY-155/200
GY	165 (black)	GY-165/20	GY-165/200
GY	170 (red)	GY-170/20	GY-170/200
GY	175 (red)	GY-175/20	GY-175/200
GY	200 (orange)	GY-200/20	GY-200/200
GY	275 (gray)	GY-275/20	GY-275/200
GY	300 (brown)	GY-300/20	GY-300/200

APPLICATION OF GM501 MediaLine



Gynemed GmbH & Co. KG
Lübecker Straße 9
23738 Lensahn
Germany

Tel.: +49 (0) 4363 90 32 90
Fax: +49 (0) 4363 90 32 9-19

info@gynemed.de
www.gynemed.de