

# CRYOTOP<sup>®</sup> SAFETY KIT

## Vitrification Protocol for Cryotop<sup>®</sup> Method

Vitrification Media VT801 / VT802 & VT601 / VT602

Cryotop<sup>®</sup> - Open System

Cryotop<sup>®</sup> SC - Closed System



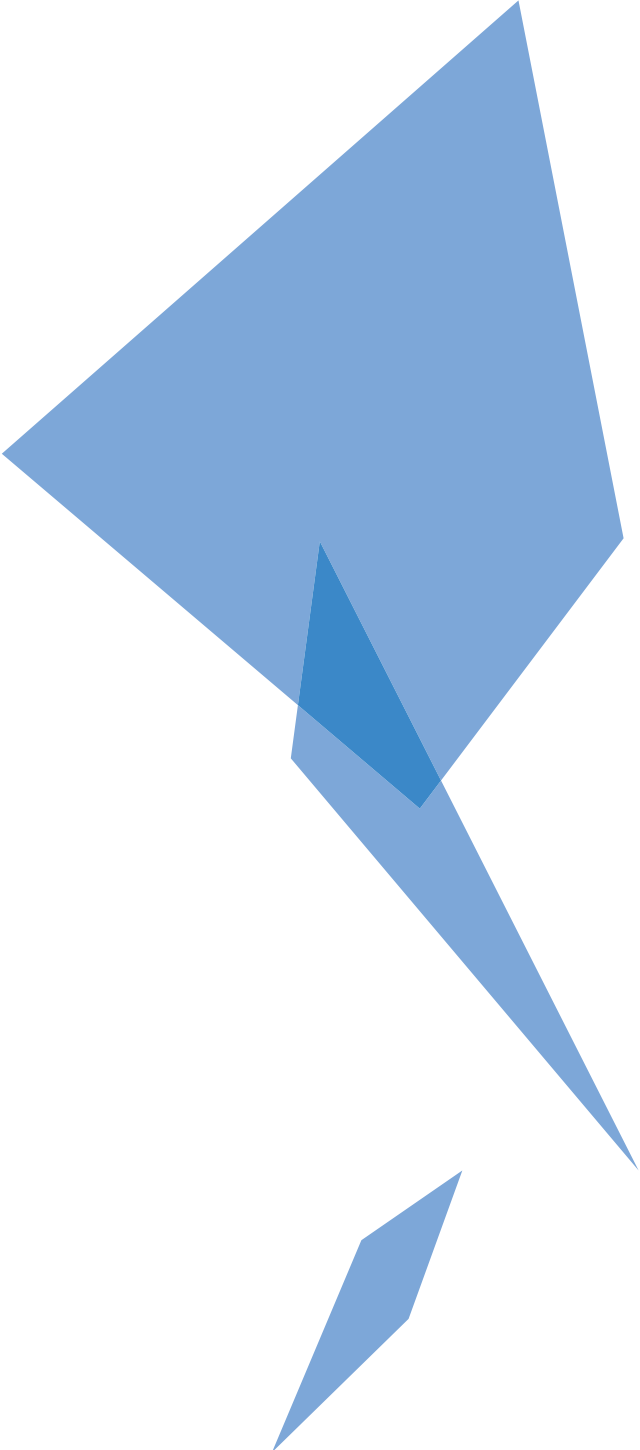

**Vitrification**

## Vitrification Procedure

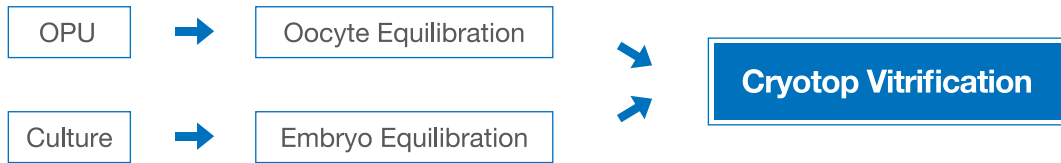

It is different procedures between Oocyte and Embryo for Equilibration.

## PART 1

# Materials Required

- Vitrification Media VT801 (Ref.91171) or VT601(Ref.91101).
  - No.0 Basic Solution (BS): 1 X 1.5mL vial (Only for Oocyte Vitrification)
  - No.1 Equilibration Solution (ES): 1 X 1.5mL vial
  - No.2 Vitrification Solution (VS): 2 X 1.5mL vials

- Cryotop
  - Cryotop® (Ref. 81111, 81112, 81113, 81114, 81115)
  - Cryotop®SC (Ref. 81121, 81122, 81123, 81124, 81125)
- Repro Plate - K1 (Ref. 83003)
- Cooling Rack (Ref. 84010): Blue styrol box for liquid nitrogen
- Pasteur Pipette **\*\*refer to CAUTION**
- Stereomicroscope (Turn off the heating plate)
- Stopwatch or Timer (with count up function)
- Liquid Nitrogen
- Tweezers
- 2 Micro pipettes: 2-20µL / 100-1000µL
- Cane
- Storage tank

### Additional Materials for Cryotop®SC

- Cooling Rack SC (Ref. 84014)
- Straw Cutter (Ref. 84117)
- Aluminum Block (Ref. 84115)
- Sealer

### CAUTION

Use a pasteur pipette that has a suitable internal diameter for Oocyte or Embryo. The external diameter of Oocyte is about 120µm and for Embryo, about 120-250µm. This is to optimize the volume of the solutions for the best dilution condition to get the highest survival rate.

## PART 2

# Preparation for Vitrification

1. Bring **BS**, **ES** and **VS** to room temperature (25-27°C).

2. Write necessary information about a patient on the handle/straw cap of Cryotop (See Figure 2-1). You can also label them.

Figure 2-1



3.

**[Cryotop]**

Fill 90% of Cooling Rack with fresh liquid nitrogen.

**[Cryotop SC for closed system]**

Place Aluminum Block in Cooling Rack SC from the beginning. Then fill with fresh liquid nitrogen until it covers the top of the Aluminum Block (See Figure 2-3).

Figure 2-2

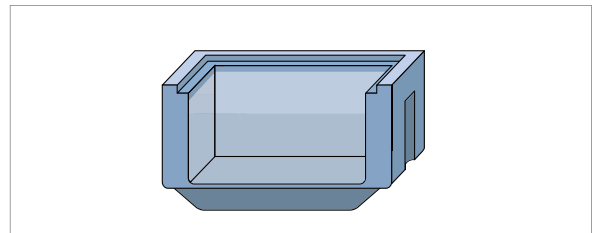
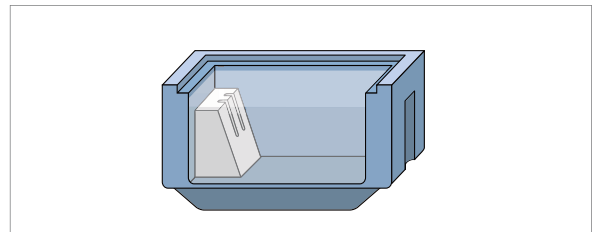

Figure 2-3



4. Remove the culture dish containing Oocyte or Embryo from the incubator. Check the quality of the Oocyte or the Embryo well with pasteur pipette under the microscope (See Figure 2-4).

**For Oocyte Vitrification, take the cumulus cells off.**

Figure 2-4

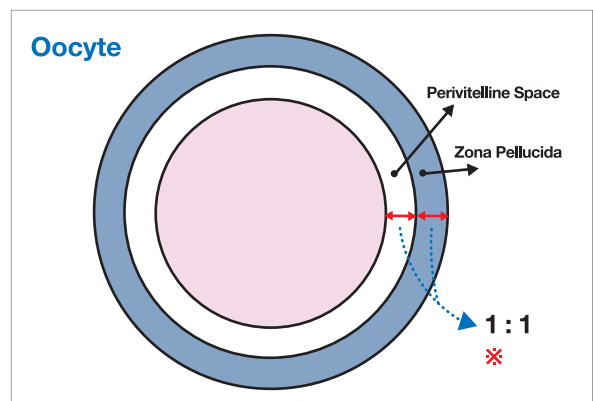

※ Compare the width of perivitelline space with thickness of zona pellucida and record it (Ex.1:1). It makes easy to know the completing of the equilibration after immersing in ES.

# PART 3

## Equilibration

### Oocyte Equilibration

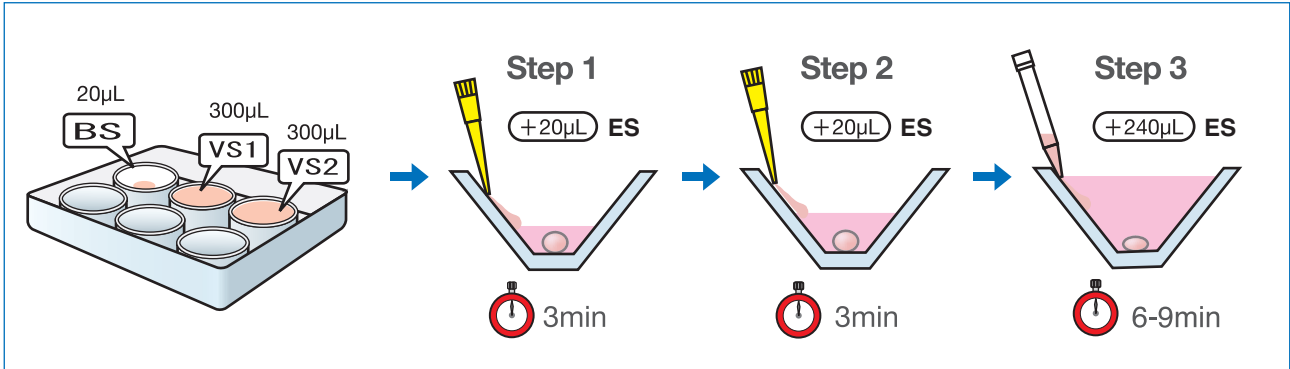

#### Oocyte Equilibration 1

Write **BS**, **VS1** and **VS2** on the lid of Repro Plate. Drop 20µL for **BS** and 300µL each for **VS1** and **VS2** on the plate with micro pipette (See Figure 3-1). Immediately put the lid on the Repro Plate.

#### Oocyte Equilibration 2

Aspirate the Oocyte at the tip of the pasteur pipette. Transfer the Oocyte with minimal volume of medium from the culture dish to the **BOTTOM** of **BS** (20µL).

#### Oocyte Equilibration 3 - For 3 minutes

Set up the stop watch (with count up function). Check the time with the stop watch for the following steps. Add **ES** 20µL gently to the **TOP** of **BS** with the Oocyte moving micro pipette along the well and leave it for 3 minutes (See Figure 3-2).

#### Oocyte Equilibration 4 - For 3 minutes

Add another **ES** 20µL gently to the **TOP** of **BS** as well and leave it for 3 minutes (See Figure 3-2).

#### Oocyte Equilibration 5 - For 6 - 9 minutes

Add another **ES** 240µL gently to the **TOP** of **BS** and leave it for 6 - 9 minutes (See Figure3-2).

For Equilibration, the volume of Oocyte is required to be recovered completely. Oocyte Equilibration is complete when the width of perivitelline space becomes equal to the width before immersing to ES.

Figure 3-1

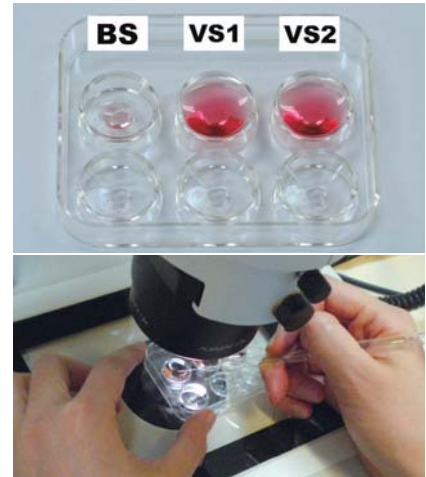
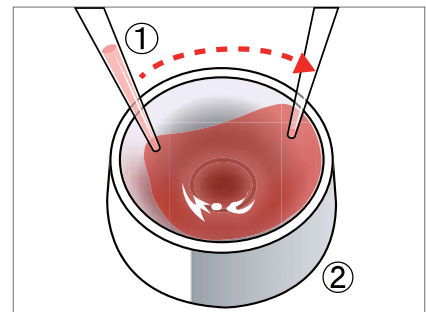
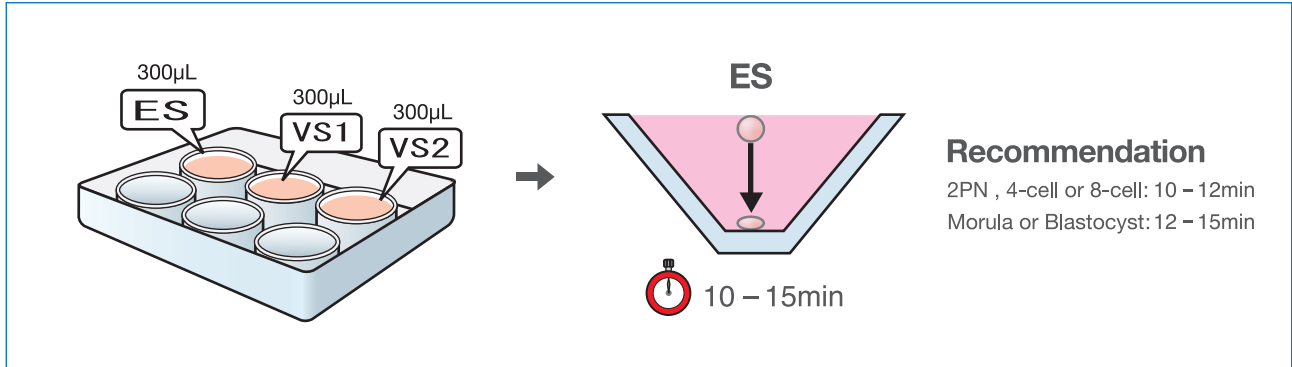

Figure 3-2



## Embryo Equilibration



### Embryo Equilibration 1

Write **ES**, **VS1** and **VS2** on the lid of Repro Plate. Gently invert each vial of **ES** and **VS** twice to mix contents. Drop each solution 300µL on the plate using micro pipette (See Figure 3-3). Immediately put the lid on the Repro Plate.

Figure 3-3



### Embryo Equilibration 2

Aspirate the Embryo at the tip of the pasteur pipette (See Figure 3-4). Put the Embryo with minimal volume of medium to the **TOP** center of **ES**.

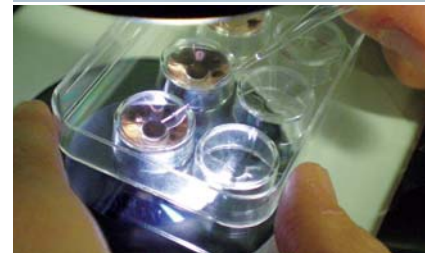

### Embryo Equilibration 3 - For 10 - 15minutes

Set up the stop watch (with count up function). Check the time with the stop watch for the following steps. The Embryo free-falls within 30 seconds. It spontaneously begins to shrink and then gradually returns to its original size with infiltrating **ES**, which indicates that the Equilibration is complete.

Figure 3-4

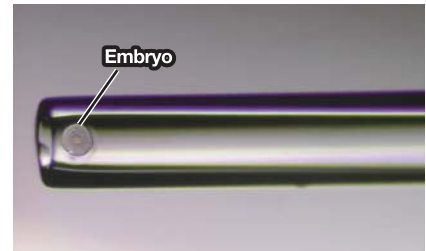

### CAUTION

For Blastocyst Equilibration, wait for disappearing of the perivitelline space. Especially, for vitrification of Blastocyst, Day 5 is recommended.

#### Equilibration time is as follows:

Oocyte :	12-15min
2PN , 4-cell or 8-cell :	10-15min
Morula or Blastocyst :	12-15min

## PART 4

# Vitrification

It is the same procedure for Oocyte and Embryo.

### Vitrification 1

After the completion of Equilibration, aspirate the Oocyte (Embryo) in **ES** at the tip of pasteur pipette (See Figure 4-1). Transfer the Oocyte (Embryo) to the **surface** center of **VS1** with minimal volume of **ES**. Blow only the Oocyte (Embryo) out to **VS1**. To avoid getting the remaining **ES** in the pasteur pipette into the **VS1**, blow out the **ES** to the outside of the well. Aspirate fresh **VS1** and blow it out again to the outside of the well. Aspirate fresh **VS1** into the pasteur pipette.

Figure 4-1

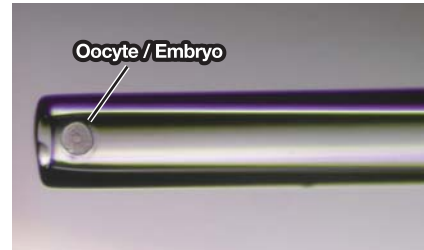

### Vitrification 2 - Within 0.5 minute

Aspirate the Oocyte (Embryo) in **VS1** with the pasteur pipette and blow it out to **VS1**. Quickly stir five times around the Oocyte (Embryo). Repeat the aspirating, blowing out and stirring three times changing the positions in **VS1** (See Figure 4-2). Displace the outer solution of the Oocyte (Embryo) to **VS1** completely until the remaining **ES** visually disappears.

### Vitrification 3 - Within 0.5 minute

Blow out the remaining **VS1** in the pasteur pipette to the outside of the well. Aspirate fresh **VS2** into the pasteur pipette, and then aspirate the Oocyte (Embryo) in **VS1** at the tip of the pipette. Transfer the Oocyte (Embryo) to **VS2** with minimal volume of **VS1**. Stir around the Oocyte (Embryo) changing positions twice with the pasteur pipette in **VS2** (See Figure 4-2). This step is completed when the outer Oocyte (Embryo) is displaced to **VS** perfectly and the flat shrinking in cause of dehydration is observed.

Figure 4-2

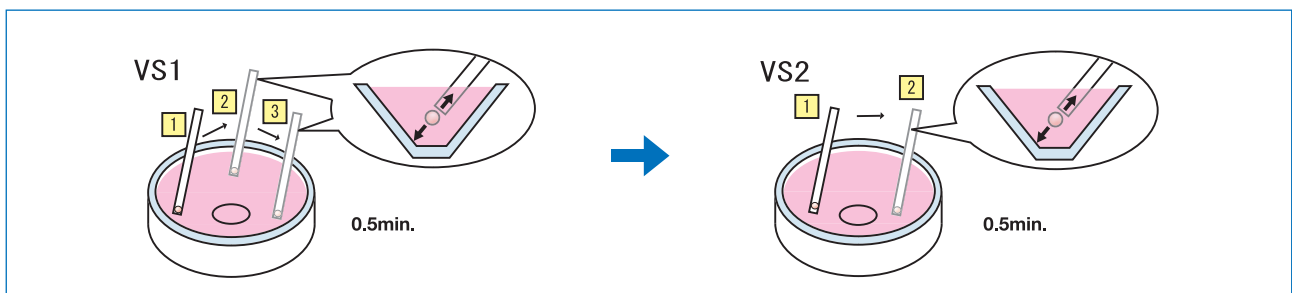

### Vitrification 4

Place the Cryotop under a microscope (Logo should be up) and adjust the focus on the black mark of the Cryotop sheet (See Figure 4-3).

Figure 4-3





## Vitrification 5

Aspirate the shrunk Oocyte (Embryo) in **VS2** at the tip of the pasteur pipette (See Figure 4-4). Place the Oocyte (Embryo) by the black mark of Cryotop sheet with minimal volume (less than 0.1 $\mu$ L) of **VS2** (See Figure 4-5a and 4-5b). For more than 2 Oocytes (Embryos), make 1 droplet for each (See Figure 4-6a and 4-6b).

Figure 4-4

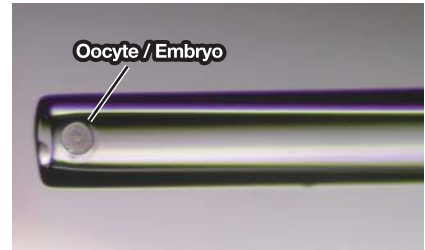

## Removal of the excess VS on the sheet

After putting Oocytes (Embryos) on the Cryotop sheet, the excess VS should be removed by aspirating using pipette.

### Step 1

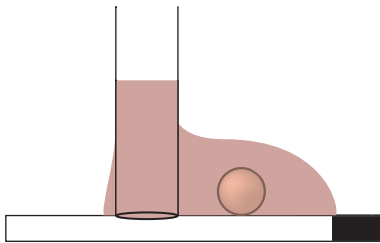

Put the top of the pipette on the bottom end of the big VS drop.

### Step 2

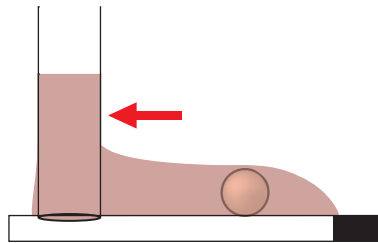

Slide the pipette horizontally to outside, and make the VS drop lower.

### Step 3

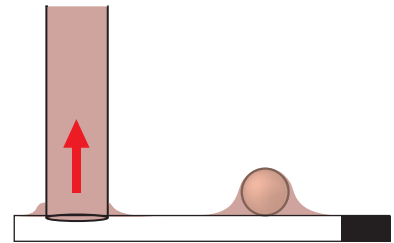

Aspirate the excess VS, and minimize the VS drop (not aspirating oocyte).

Figure 4-5a

### Good example

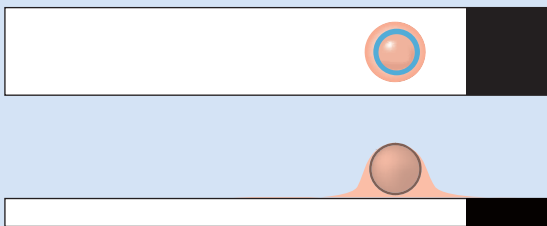

Make a planar droplet by the black mark of Cryotop sheet.

Figure 4-5b

### Bad example

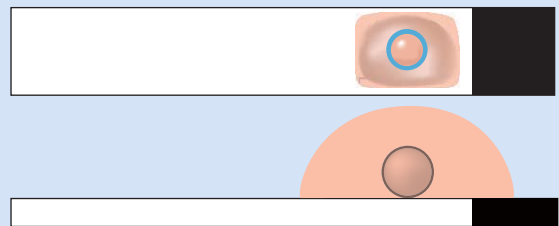

Make a steric droplet by the black mark of Cryotop sheet. The volume of VS2 is too much.

Figure 4-6a

### Good example

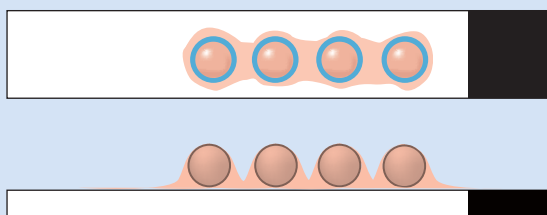
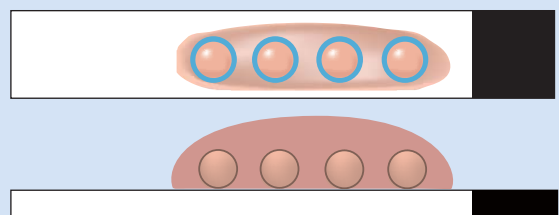

Figure 4-6b

### Bad example



## Cryotop® and Cryotop® SC have different procedures.

### Cryotop® – Open System

#### Vitrification 6-A

Plunge the Cryotop directly into liquid nitrogen. Hold the straw cap with tweezers and insert the Cryotop from sheet end in liquid nitrogen. Then fit the Cryotop with the straw cap by hands screwing tightly in the air (See Figure 4-7).

Figure 4-7

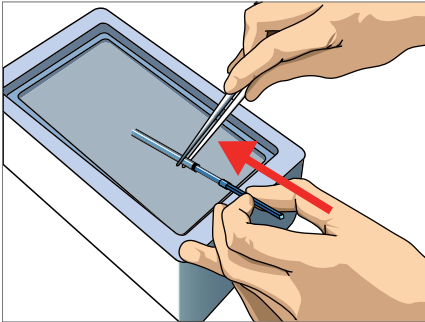

Hold the straw cap with tweezers and insert the Cryotop into it.

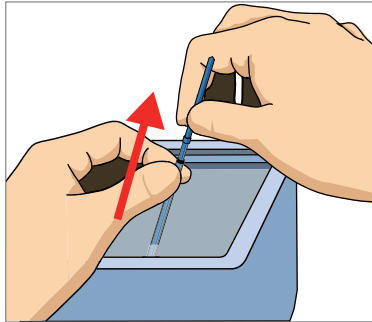

Hold the straw cap with fingers and fit it.

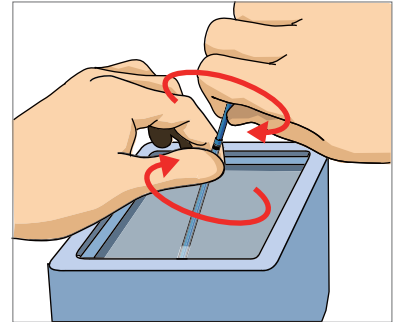

Twist it and make sure if the straw cap fits tightly to the Cryotop.



#### CAUTION

Keep the Cryotop sheet in the liquid nitrogen until transferring to a storage tank. In transferring the Cryotop to other storage tank, keep it in liquid nitrogen. Do not expose of the Cryotop in air until Thawing.

## Cryotop®SC – Closed System for Storage Vitrification 6-B

Plunge the CryotopSC directly into liquid nitrogen. Insert the CryotopSC into the straw cap without putting liquid nitrogen in it. Then seal the straw cap (See Figure 4-8).

Figure 4-8

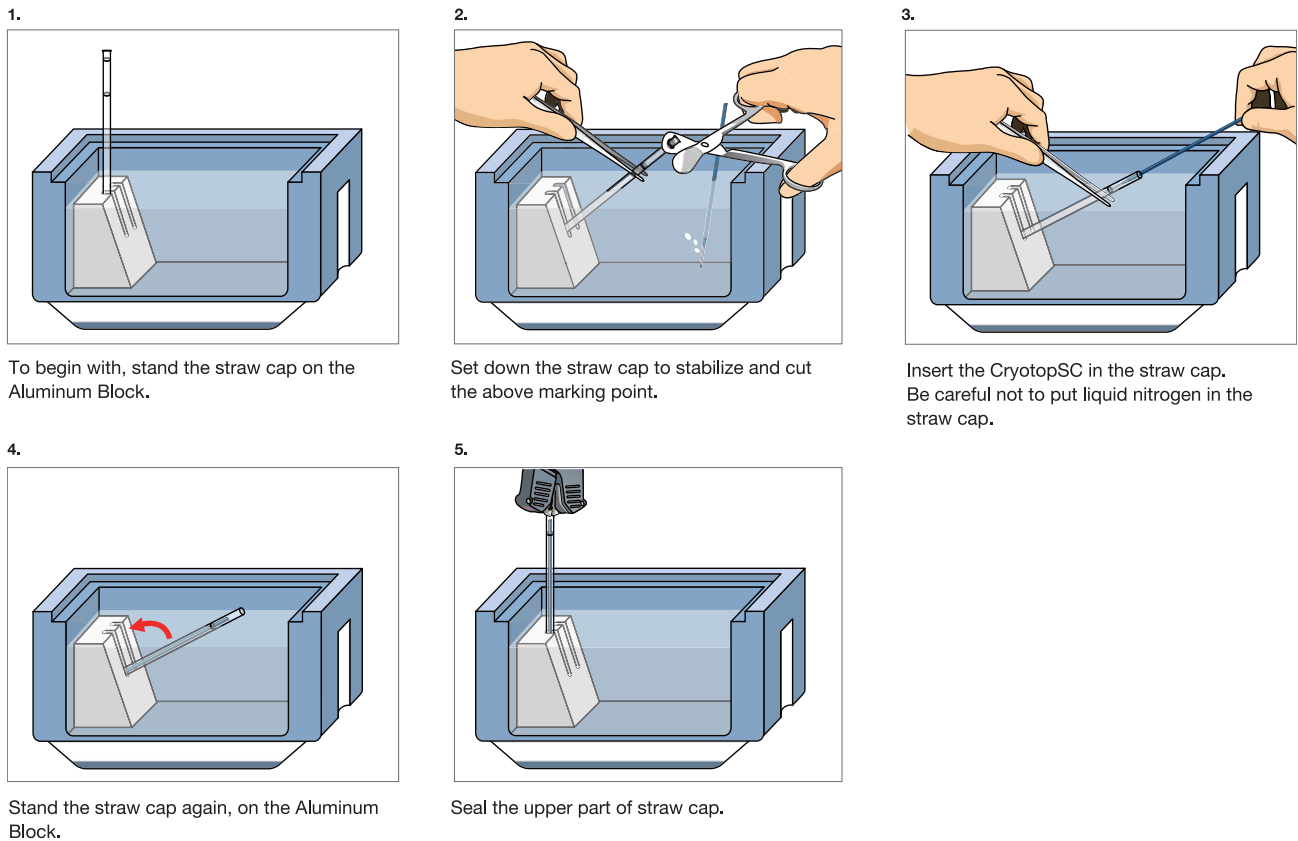

### POINT

When you seal the straw cap, be careful not to put liquid nitrogen in it. Temperature is kept under  $-150^{\circ}\text{C}$  within the height of 2.5cm above surface of liquid nitrogen. Be careful not to raise the CryotopSC sheet above 2.5cm high. To identify the surface of liquid nitrogen, you can see the black mark on the straw cap.

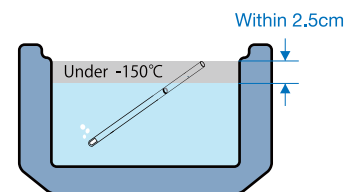

### CAUTION

Keep the CryotopSC in the liquid nitrogen until transferring to a storage tank. In transferring the CryotopSC to other storage tank, keep it in liquid nitrogen. Do not expose of the CryotopSC in air until Thawing.

## Cryotop®SC – Complete Closed System Vitrification 6-C

Without direct contact with liquid nitrogen, insert the CryotopSC into the straw cap pre-set at the Aluminum Block. Then seal the straw cap (See Figure 4-9).

Figure 4-9

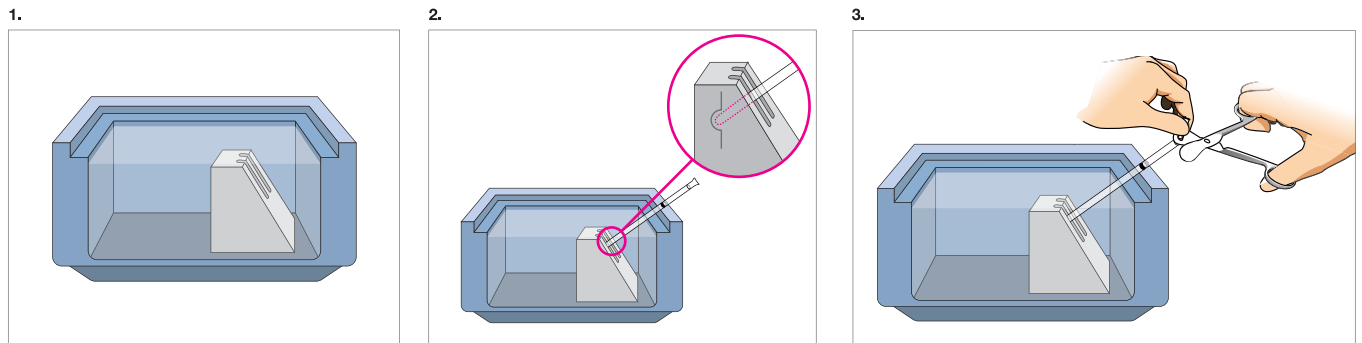

1. Preliminarily, fill liquid nitrogen above the surface of the Aluminum Block in the Cooling Rack and leave it until boiling stops. (About 5 min.)

2. Stand the straw cap.

3. Cut the upper black marking point on the straw cap with the Straw Cutter.

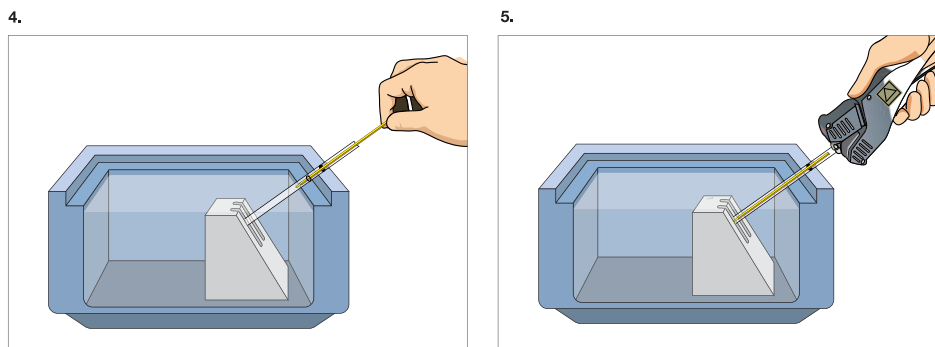

4. Insert the CryotopSC in the straw cap

5. Seal the upper part of the straw cap with the Sealer.

### POINT

Lean the upper part of the straw cap against the Cooling Rack. This positioning avoids influence of cool air from liquid nitrogen.

Within 2.5cm

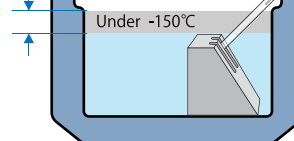

### CAUTION

Keep the CryotopSC in the liquid nitrogen until transferring to a storage tank. In transferring the CryotopSC to other storage tank, keep it in liquid nitrogen. Do not expose of the CryotopSC in air until Thawing.





Thawing

## PART 1

# Materials Required

- Thawing Media VT802 (Ref.91182) or VT602 (Ref.91121).  
No.1 Thawing Solution (TS): 2 X 4mL vial  
No.2 Diluent Solution (DS): 1 X 4mL vial  
No.3 Washing Solution (WS): 1 X 4mL vial
- Repro Plate - K1 (Ref. 83003)
- 2 Petri Dish
- Cooling Rack (Ref. 84010): Blue styrol box for liquid nitrogen
- Pasteur Pipette **\*\*refer to CAUTION**
- Stereomicroscope (Turn off the heating plate)
- Stopwatch or Timer (with count up function)
- Liquid Nitrogen
- Tweezers
- 1 Micro pipette: 100-1000 $\mu$ L

### Additional Materials for Cryotop®SC

- Straw Cutter (Ref. 84117)



### CAUTION

Use a pasteur pipette that has a suitable internal diameter for Oocyte or Embryo. The external diameter of Oocyte is about 120 $\mu$ m and for Embryo, about 120-250 $\mu$ m. This is to optimize the volume of the solutions for the best dilution condition to get the highest survival rate.

## PART 2

## Preparation for Thawing

1. Warm **TS** vial (sealed) with a Petri Dish in an incubator to 37°C(>1.5hours).

2. Bring **DS** and **WS** to room temperature (25~27°C).

3. Retrieve the cane which has the specific Cryotop, quickly immerse the cane in a Cooling Rack filled with fresh liquid nitrogen. Retrieve the specific Cryotop from the cane in the liquid nitrogen. Check the information about the patient on the label of Cryotop.

**CAUTION**

Place the Cooling Rack by the stereo microscope.

4. Write **DS**, **WS1** and **WS2** on the lid of a Repro Plate. Gently invert each vial of **DS** and **WS** twice to mix contents. Drop 300µL each for **DS**, **WS1** and **WS2** on the Repro Plate with micro pipette. Place it on the microscope stage and lid it.

Remove **TS** vial and the Petri Dish from the incubator and place the Petri Dish on the microscope stage. Gently invert the vial of **TS** twice to mix contents and pour the full contents into the Petri Dish (See Figure 2-1).

Figure 2-1

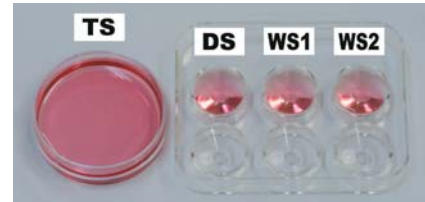

5. Adjust the focus of the microscope to the Petri Dish with **TS**.

Use pasteur pipette in order to focus easily on the center of the Petri Dish (See Figure 2-2).

Figure 2-2

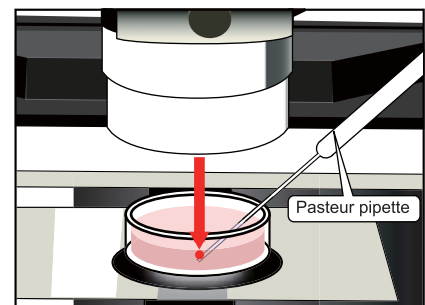



## PART 3

# Thawing

Cryotop® and Cryotop®SC have different procedures.

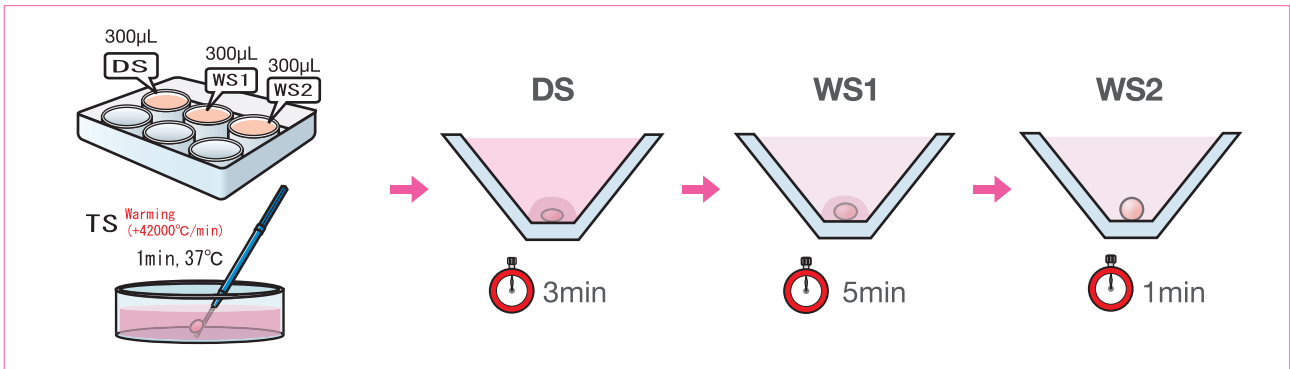

## Cryotop® - Open System

### Thawing 1

Carefully twist and remove the straw cap from the Cryotop in liquid nitrogen (See Figure 3-1). Prop it against the corner of the Cooling Rack.

Figure 3-1

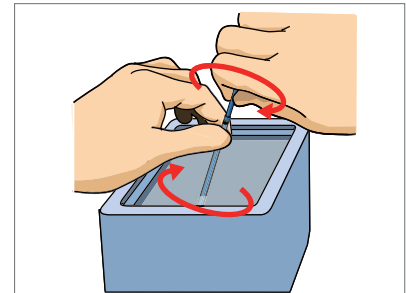

Set up the stop watch (with count up function). Check the time with the stop watch for the following steps.

### Thawing 2

Be ready to use pasteur pipette keeping the Cryotop in liquid nitrogen. Set up the stop watch (with count up function). Check the time with the stop watch for the following steps.

### Thawing 3 - For 1 minute

Quickly immerse Cryotop sheet into **TS** on the microscope stage. It should be within 1 second (See figure 3-2). Find the Oocyte (Embryo) adjusting the focus on the black mark of the Cryotop sheet. 1 minute after immersing into **TS**, gently aspirate the Oocyte (Embryo) with the pasteur pipette after dispensing it from the sheet. Aspirate the Oocyte (Embryo) even if it does not dispense from the sheet. Also, aspirate **TS** until the Oocyte (Embryo) reaches 2mm from the tip of the pasteur pipette (See Figure 3-3).

Figure 3-2

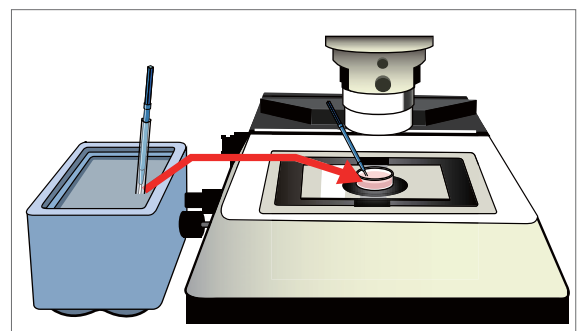
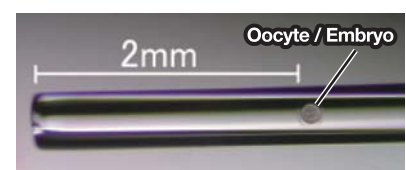

Figure 3-3



## Cryotop® SC - Closed System

### Thawing 1

Stand the CryotopSC on the Aluminum Block.

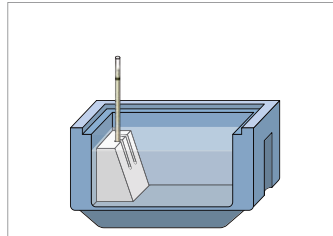

### Thawing 2

Cut the marking point with Straw Cutter.

Put the cutting blade at the black marking point.

Turn the straw cap slowly to cut.

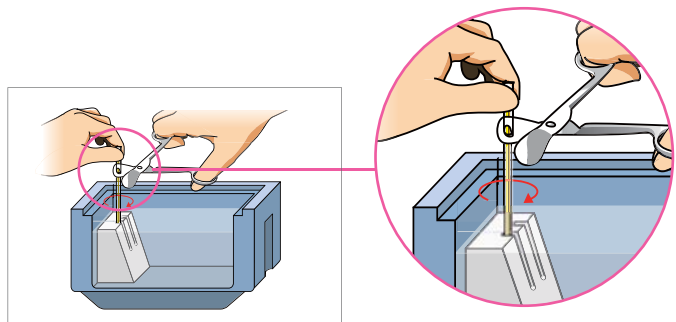

### Thawing 3

Be ready to use pasteur pipette keeping the CryotopSC in liquid nitrogen. Set up the stop watch (with count up function). Check the time with the stop watch for the following steps.

### Thawing 4

Insert the cut piece of the straw cap into the space between the CryotopSC and the Aluminum Block. This is to take out the CryotopSC easier.

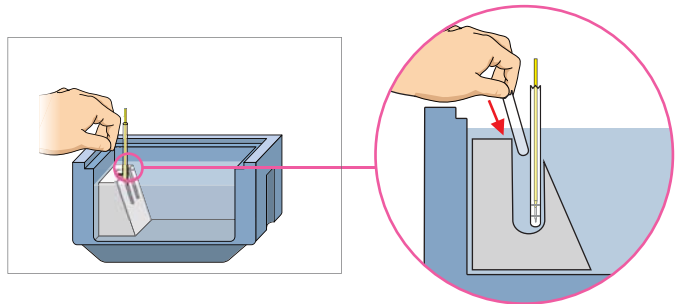

### Thawing 5 – For 1 minute

Quickly immerse the CryotopSC sheet into **TS** on the microscope stage by transferring it linearly. It should be within 1 second (See Figure 3-4). Find the Oocyte (Embryo) adjusting the focus on the black mark of the Cryotop sheet. 1 minute after immersing into **TS**, gently aspirate the Oocyte (Embryo) with the pasteur pipette after dispensing it from the sheet. Aspirate the Oocyte (Embryo) even if it does not dispense from the sheet. Also, aspirate **TS** until the Oocyte (Embryo) reaches 2mm from the tip of the pasteur pipette (See Figure 3-5).

Figure 3-4

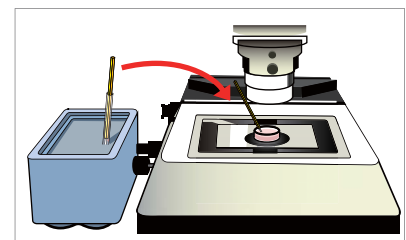
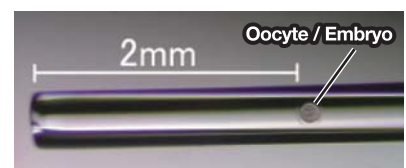

Figure 3-5



## PART 4

# Dilution

### Dilution - For 3 minutes

Blow out only **TS** in the pasteur pipette into the **BOTTOM** center of **DS** slowly (See Figure 4-1a), then gently place the Oocyte (Embryo) on the bottom of the **TS** layer (See Figure 4-1b). Leave it for 3 minutes. This is for mostly gradual displacement from **TS** to **DS**.

Figure 4-1a

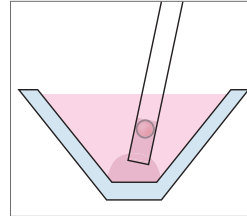
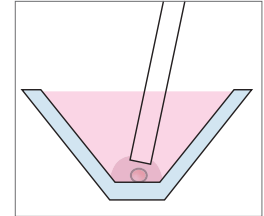

Figure 4-1b



## PART 5

# Washing

### Washing 1 - For 5 minutes

3 minutes later, after immersing into **DS**, gently aspirate the Oocyte (Embryo) in **DS** with the pasteur pipette. Also, aspirate **DS** until the Oocyte (Embryo) reaches 2mm from the tip of the pasteur pipette (See Figure 5-1).

Figure 5-1

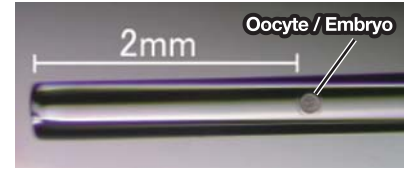

Blow out only **DS** in the pasteur pipette into the **BOTTOM** center of **WS1** slowly (See Figure 5-2a), then gently place the Oocyte (Embryo) on the bottom there (See Figure 5-2b). Leave it for 5 minutes. This is also for mostly gradual displacement from **DS** to **WS1**.

Figure 5-2a

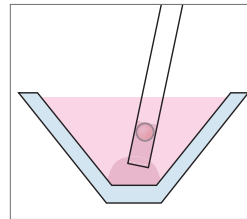
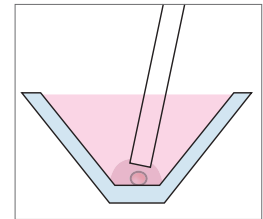

Figure 5-2b



### Washing 2 - For 1 minute

5 minutes later, after immersing into **WS1**, aspirate the Oocyte (Embryo) with minimal volume of **WS1** with pasteur pipette (See Figure 5-3) and transfer it to the **TOP** center of **WS2**. After the Oocyte (Embryo) free-falls to the bottom of **WS2**, do the same work again in **WS2** (See Figure 5-4).

Figure 5-3

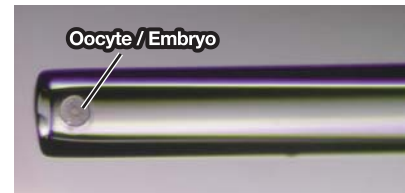
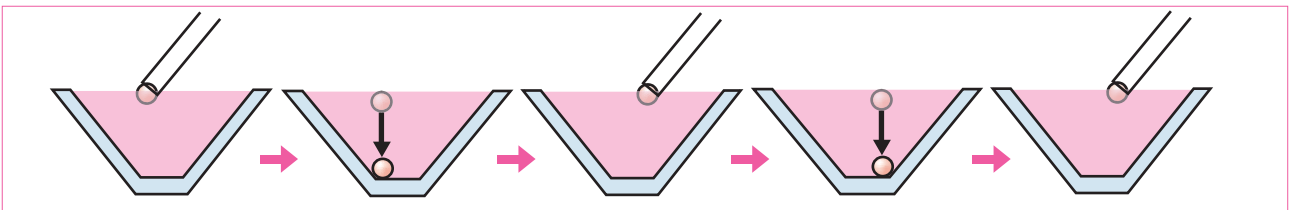

Figure 5-4



### Washing 3

Transfer the Oocyte (Embryo) to a culture dish containing the appropriate culture medium. Incubate the Oocyte (Embryo) in a 37°C incubator to complete recovery.

Completion of recovery : Oocyte (Embryo) for 2 hours for recommendation.

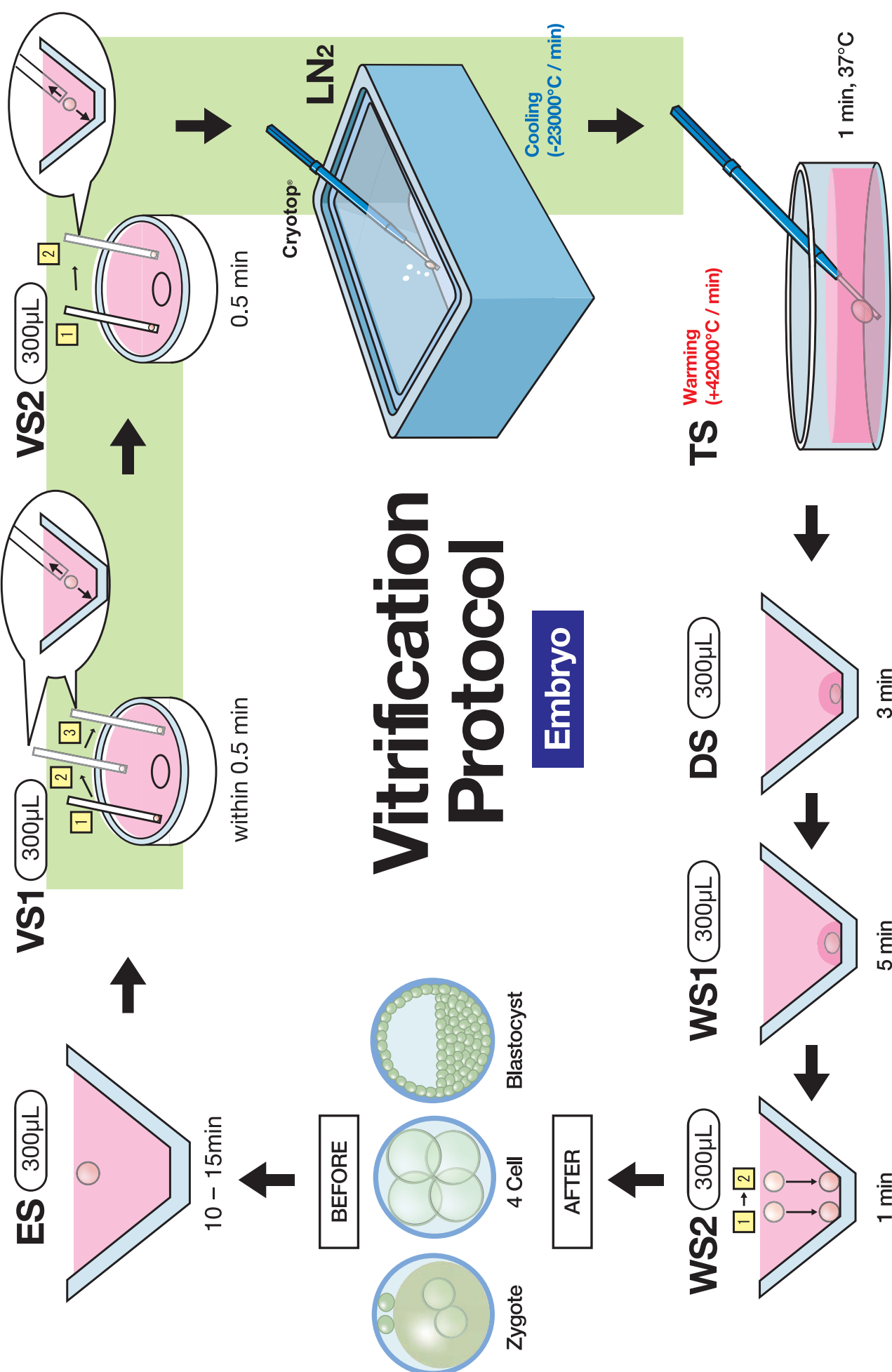

# Vitrification Protocol

**Embryo**

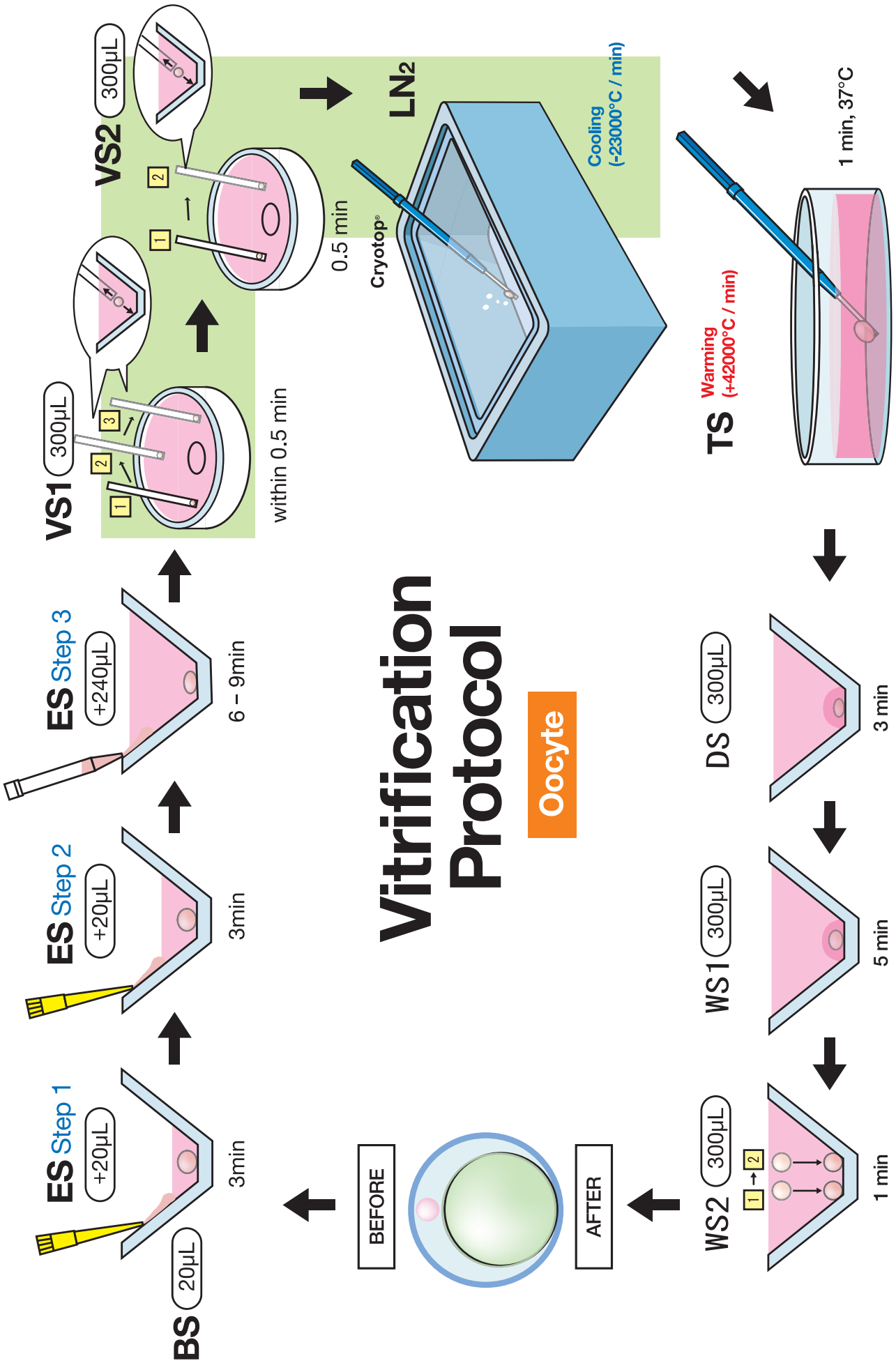



**KITAZATO®**

**[www.kitazato.co.jp](http://www.kitazato.co.jp)**